



Design and Construction Manual



**An In Depth Guide for Specifiers,
Engineers and Installers**



ReCon
Retaining Walls

Aesthetics You Want... ...Performance You Need!

Scale...

Options for Home, Business, & DOT

Texture...

Natural stone appearance

Shapes...

Flexibility and choices that work

Durability...

Wet-Cast, Air-Entrained Concrete

Solutions...

A product that doesn't dictate wall needs: **It Accommodates them!**



A Note from ReCon to our Specifiers, Engineers, Wall Installers, and Customers:

*When we first started ReCon Retaining Walls, we set out to do more than just supply a product ... we made it our mission to provide **SOLUTIONS and ADD VALUE**. With this idea in mind, we carefully engineered and crafted each one of our blocks to serve a specific purpose. So, whether your project focuses on scale and aesthetics, durability, site constraints, or construction efficiencies, we are confident that we have a product that will solve your site-specific challenges.*

As you know, the proper design and construction of a retaining wall is essential. ReCon recognizes the important role that YOU; our specifiers, engineers, and installers, play in delivering a site solution that provides long lasting value for your customers. ReCon wants to assist you when working on grade separation projects by providing tools that explain the special characteristics of ReCon and how they can be used to address the challenges at hand. ReCon's Design and Construction Manual includes comprehensive and specific information for each of our block families; Retaining Walls, Fence and Guardrail Walls, and Columns, in a convenient and easy to use format. We recommend that this information be used in combination with the additional material available on our website, reconwalls.com. Armed with these resources, we believe that you will have a successful project and a ReCon retaining wall that will perform as designed and remain attractive for years to come.

If you require any additional information or there is anything that we can help you with, please feel free to contact us.

Sincerely,

The ReCon Team

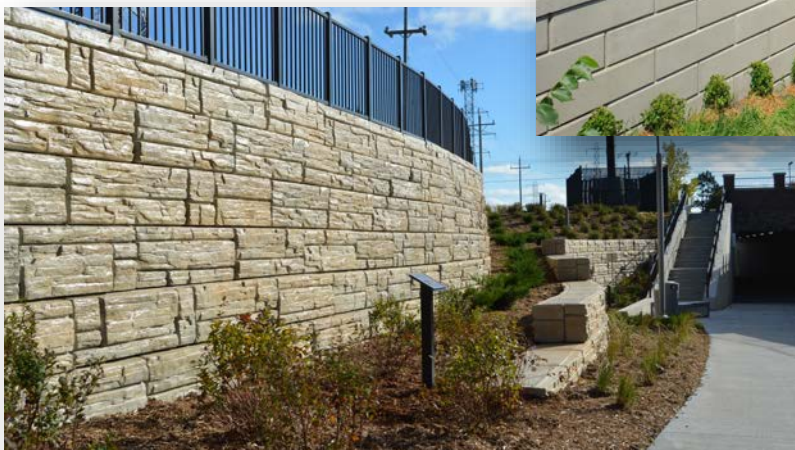
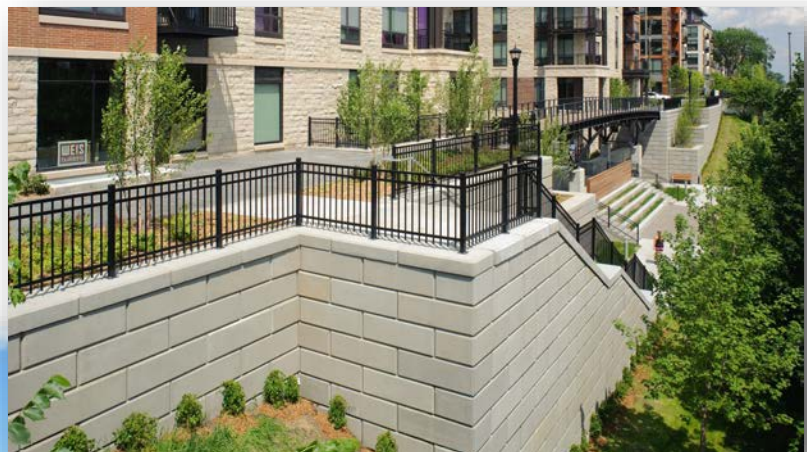

Table of Contents

Products

- ReCon Block Catalog 8
- Textures
 - LeSueur County Limestone..... 15
 - North Shore Granite 15
 - Old World 15
 - Rustic 15
 - Weathered Edge..... 15

Design Considerations

- Retaining Walls
 - Wall Geometry 19
 - Site Geometry..... 19
 - Soils Information 20
 - Project Specification 22
 - ReConWall Analysis Software 22
 - ReCon Wall Charts..... 23
 - Gravity Wall Charts* 25
 - Geogrid Reinforced Wall Charts* 27
 - Multiple Setback Options 30
 - Water Applications 31
 - Drainage and Water Management..... 32
 - Terraced Walls..... 33
 - Global Stability 34
- Independent Pedestrian Railings, Fences and Traffic Barriers 35
- Integral Pedestrian Railings and Fences..... 36
- Fence and Guardrail Block Walls
 - Independent and Integral Free-Standing Walls..... 37
 - Integral Traffic Barrier 38
- Column Blocks..... 39

Construction

- Retaining Walls
 - Documenting the Scope of Work 42
 - Preconstruction Meeting..... 42
 - Engineered Shop Drawings..... 42
 - Site Preparation 43
 - Excavation 43
 - Preparing the Leveling Pad..... 44

Retaining Walls Cont.

Base Course Installation	45
Backfilling and Compaction	45
Placing Additional Courses	46
Geogrid Placement	47
Curved Walls.....	48
Geogrid Placement on Curved Walls.....	49
Outside 90-degree Corners	50
Inside 90-degree Corners	50
Double Outside 90-degree Corners.....	51
Outside 90-degree Corner to Abutment	51
Top of Wall Treatments.....	52
<i>ReCon Top Blocks</i>	52
<i>Cap Blocks</i>	53
<i>Full-High Cap Blocks</i>	54
Steps	55
Independent Pedestrian Railings, Fences, and Traffic Barriers	55
Integral Pedestrian Railings and Fences	56
Staining and Sealing.....	56
Construction Documentation	57

Fence and Guardrail Block Walls

Independent and Integral Free-Standing Walls.....	58
Traffic Barriers	59
Curved Walls — Fence Block	59
Curved Walls — Guardrail Block.....	61
90-degree Corners	62
Course Transition.....	63

Column Block Installation Options

Column Block with Fence Rails	64
Column Block with Gate	65
Column Block with Fence	65

ReCon Specification.....	66
--------------------------	----

Warranty.....	73
---------------	----

Notes

A large grid of graph paper for taking notes, consisting of 20 columns and 30 rows of small squares.

Products

ReCon Block Catalog

ReCon blocks are available in a wide variety of shapes, types and sizes. Each of the block types have been designed to enhance the aesthetic appearance of a finished retaining wall. In addition, the large selection of shapes and types provides ease and simplicity in the installation process without adding undue complexity for designers, installers or manufacturers.

ReCon offers four distinct types of blocks that are intended to meet any requirement that a project may have. These block types include:

- Retaining Wall Blocks
- Top of Wall Blocks
- Fence Blocks (freestanding)
- Column Blocks

The blocks shown within our block catalog are representative of the most common ReCon block shapes. Actual block shapes and texture options can vary by region so it is best to **check with your local supplier to determine availability.**

Because ReCon blocks are produced using wet-cast concrete, they lend themselves to a varying degree of customization. Many existing shapes and face textures that we offer today were originally developed to accommodate the needs of an owner, designer or installer. If your project requires a unique shape or texture, it may be possible to develop products not already available. Given a reasonable amount of time, ReCon producers should be able to determine the viability and cost estimate of such a request.

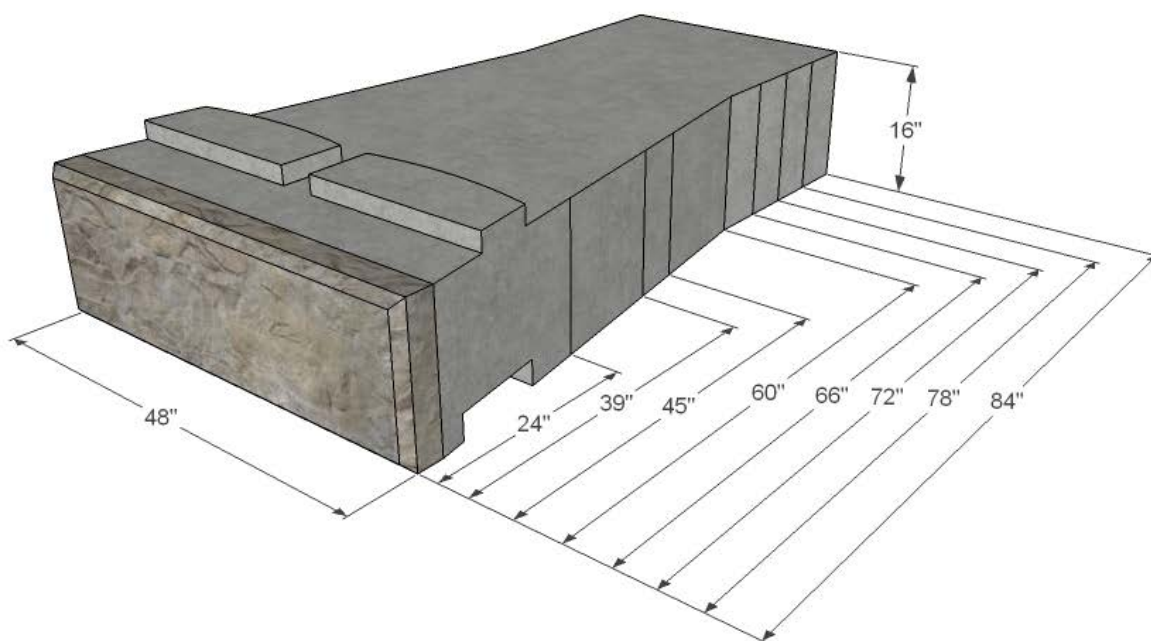



Retaining Wall Blocks

Base Block			
Wall Coverage	Batter	Front Face Dimensions	
5.33 sf	3.6°	16 in x 48 in	
			
Unit ID	Depth (in)	Volume (cf)	Weight (lb)
24B	24	10.04	1456
39B	39	15.70	2277
45B	45	17.58	2549
60B	60	21.88	3173
66B	66	23.56	3416
72B	72	25.24	3660
78B	78	26.91	3902
84B	84	28.59	4146

Middle Block			
Wall Coverage	Batter	Front Face Dimensions	
5.33 sf	3.6°	16 in x 48 in	
			
Unit ID	Depth (in)	Volume (cf)	Weight (lb)
24M	24	9.73	1411
39M	39	15.18	2201
45M	45	17.18	2491
60M	60	21.48	3115
66M	66	23.16	3358
72M	72	24.84	3602
78M	78	26.51	3844
84M	84	28.19	4088

Base Channel Block			
Wall Coverage	Batter	Front Face Dimensions	
5.33 sf	26.6°	16 in x 48 in	
			
Unit ID	Depth (in)	Volume (cf)	Weight (lb)
39BCHAN	39	15.68	2274
45BCHAN	45	17.68	2564
60BCHAN	60	22.20	3219
66BCHAN	66	23.88	3463
72BCHAN	72	25.56	3706
78BCHAN	78	27.24	3950
84BCHAN	84	28.91	4192

Middle Channel Block			
Wall Coverage	Batter	Front Face Dimensions	
5.33 sf	26.6°	16 in x 48 in	
			
Unit ID	Depth (in)	Volume (cf)	Weight (lb)
39MCHAN	39	15.35	2225
45MCHAN	45	17.35	2515
60MCHAN	60	21.87	3170
66MCHAN	66	23.55	3414
72MCHAN	72	25.23	3658
78MCHAN	78	26.91	3901
84MCHAN	84	28.58	4143

Half Block			
Wall Coverage	Batter	Front Face Dimensions	
2.67 sf	3.6°	16 in x 24 in	
			
Unit ID	Depth (in)	Volume (cf)	Weight (lb)
24H	24	4.60	667
39H	39	6.71	973

Reversible Corner Block			
Wall Coverage	Batter	Front Face Dimensions	
8.00 sf	3.6°	16 in x 48 in	
			
Unit ID	Depth (in)	Volume (cf)	Weight (lb)
C	24	9.66	1401

Retaining Wall Blocks Continued

Step Unit			
Wall Coverage	Batter	Front Face Dimensions	
2.17 sf	NA	6.5 in x 24 in	
			
Unit ID	Depth (in)	Volume (cf)	Weight (lb)
STEP	26	4.69	680

Fitting Block			
Wall Coverage	Batter	Front Face Dimensions	
5.33 sf	3.6°	16 in x 48 in	
			
Unit ID	Depth (in)	Volume (cf)	Weight (lb)
24FIT	24	8.38	1215
39FIT	39	12.86	1865

Specialty / Custom Blocks

Plinth Block			
Wall Coverage	Batter	Front Face Dimensions	
2.67 sf	3.6°	16 in x 24 in	
			
Unit ID	Depth (in)	Volume (cf)	Weight (lb)
PLB	47	10.25	1486

8-inch Capstone			
Wall Coverage	Batter	Front Face Dimensions	
2.67 sf	NA	8 in x 48 in	
			
Unit ID	Depth (in)	Volume (cf)	Weight (lb)
8CAP	26	5.78	838

Three Quarter Block			
Wall Coverage	Batter	Front Face Dimensions	
4.00 sf	3.6°	16 in x 36 in	
			
Unit ID	Depth (in)	Volume (cf)	Weight (lb)
24TQ	24	7.15	1037
39TQ	39	10.94	1586

Top of Wall Blocks

Top Block			
Wall Coverage 5.33 sf	Batter 3.6°	Front Face Dimensions 16 in x 48 in	
			
Unit ID	Depth (in)	Volume (cf)	Weight (lb)
24T	24	6.78	983
39T	39	10.52	1525

Half Top Block			
Wall Coverage 2.67 sf	Batter 3.6°	Front Face Dimensions 16 in x 24 in	
			
Unit ID	Depth (in)	Volume (cf)	Weight (lb)
24HT	24	3.22	467
39HT	39	4.66	676

Left Corner Top Block			
Wall Coverage 8.00 sf	Batter 3.6°	Front Face Dimensions 16 in x 48 in	
			
Unit ID	Depth (in)	Volume (cf)	Weight (lb)
LCT	24	7.61	1103

Right Corner Top Block			
Wall Coverage 8.00 sf	Batter 3.6°	Front Face Dimensions 16 in x 48 in	
			
Unit ID	Depth (in)	Volume (cf)	Weight (lb)
RCT	24	7.61	1103

Capstone			
Wall Coverage 2.17 sf	Batter NA	Front Face Dimensions 6.5 in x 48 in	
			
Unit ID	Depth (in)	Volume (cf)	Weight (lb)
CAP	26	3.80	551

End Capstone			
Wall Coverage 2.17 sf	Batter NA	Front Face Dimensions 6.5 in x 48 in	
			
Unit ID	Depth (in)	Volume (cf)	Weight (lb)
ECAP	26	3.80	551

Full High Cap Middle and Fitting Middle			
Wall Coverage 5.33 sf	Batter 0°	Front Face Dimensions 16 in x 48 in	
			
Unit ID	Depth (in)	Volume (cf)	Weight (lb)
FHC	24	10.00	1450
FHCMF	24	9.15	1327

Full High Cap End			
Wall Coverage 10.67 sf	Batter 0°	Front Face Dimensions 16 in x 48 in	
			
Unit ID	Depth (in)	Volume (cf)	Weight (lb)
FCHE	24	10.06	1459

Fence and Guardrail Block

Fence Base			
Wall Coverage	Batter	Front Face Dimensions	
5.33 sf	0°	16 in x 48 in	
			
Unit ID	Depth (in)	Volume (cf)	Weight (lb)
FB	24	10.67	1547

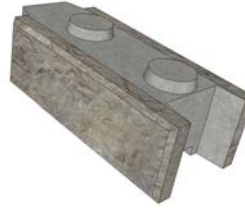
Fence Middle			
Wall Coverage	Batter	Front Face Dimensions	
5.33 sf	0°	16 in x 48 in	
			
Unit ID	Depth (in)	Volume (cf)	Weight (lb)
FM	24	9.99	1449

Fence Base Flat End			
Wall Coverage	Batter	Front Face Dimensions	
5.33 sf	0°	16 in x 48 in	
			
Unit ID	Depth (in)	Volume (cf)	Weight (lb)
FBFE	24	10.03	1454

Fence Middle Flat End			
Wall Coverage	Batter	Front Face Dimensions	
5.33 sf	0°	16 in x 48 in	
			
Unit ID	Depth (in)	Volume (cf)	Weight (lb)
FMFE	24	9.40	1363

Fence Base End			
Wall Coverage	Batter	Front Face Dimensions	
8.00 sf	3.6°	16 in x 48 in	
			
Unit ID	Depth (in)	Volume (cf)	Weight (lb)
FBE	24	10.67	1547

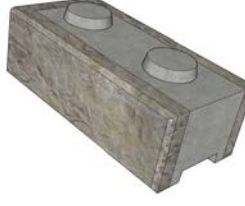
Fence Middle End			
Wall Coverage	Batter	Front Face Dimensions	
8.00 sf	0°	16 in x 48 in	
			
Unit ID	Depth (in)	Volume (cf)	Weight (lb)
FME	24	10.18	1476

Fence and Guardrail Block Continued

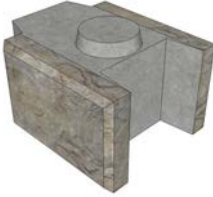
Half Fence Base			
Wall Coverage	Batter	Front Face Dimensions	
2.67 sf	0°	16 in x 24 in	
			
Unit ID	Depth (in)	Volume (cf)	Weight (lb)
HFB	24	5.24	760

Guardrail Middle			
Wall Coverage	Batter	Front Face Dimensions	
5.33 sf	0°	16 in x 48 in	
			
Unit ID	Depth (in)	Volume (cf)	Weight (lb)
GM	24	9.47	1373

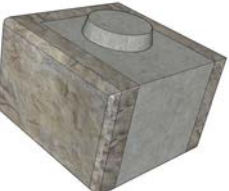
Half Fence Base End			
Wall Coverage	Batter	Front Face Dimensions	
5.33 sf	0°	16 in x 24 in	
			
Unit ID	Depth (in)	Volume (cf)	Weight (lb)
HFBE	24	5.43	787

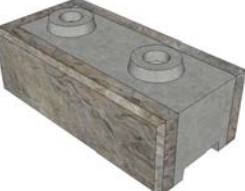
Guardrail End			
Wall Coverage	Batter	Front Face Dimensions	
8.00 sf	0°	16 in x 48 in	
			
Unit ID	Depth (in)	Volume (cf)	Weight (lb)
GE	24	9.66	1401

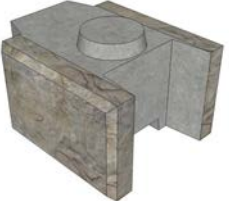
Half Fence Middle			
Wall Coverage	Batter	Front Face Dimensions	
2.67 sf	0°	16 in x 24 in	
			
Unit ID	Depth (in)	Volume (cf)	Weight (lb)
HFM	24	4.90	711

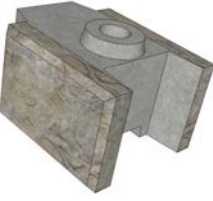
Half Guardrail Middle			
Wall Coverage	Batter	Front Face Dimensions	
2.67 sf	0°	16 in x 24 in	
			
Unit ID	Depth (in)	Volume (cf)	Weight (lb)
HGM	24	4.64	673

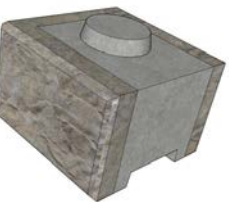
Half Fence Middle End			
Wall Coverage	Batter	Front Face Dimensions	
5.33 sf	0°	16 in x 24 in	
			
Unit ID	Depth (in)	Volume (cf)	Weight (lb)
HFME	24	5.15	747

Half Guardrail Middle End			
Wall Coverage	Batter	Front Face Dimensions	
5.33 sf	0°	16 in x 24 in	
			
Unit ID	Depth (in)	Volume (cf)	Weight (lb)
HGME	24	4.89	709

Column Block

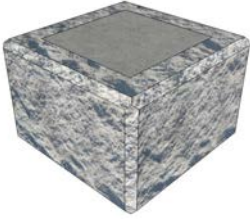
Column Block			
Face Dimensions 16 in x 24 in			
			
Unit ID	Depth (in)	Volume (cf)	Weight (lb)
CB	24	5.33	773

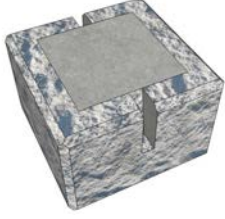
Column Block for Fence Rail - Runner			
Face Dimensions 16 in x 24 in			
			
Unit ID	Depth (in)	Volume (cf)	Weight (lb)
CBFRR	24	5.20	754

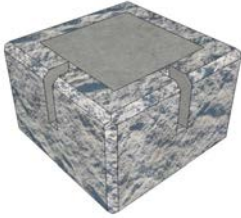
Column Block for Fence Rail - Corner			
Face Dimensions 16 in x 24 in			
			
Unit ID	Depth (in)	Volume (cf)	Weight (lb)
CBFRC	24	5.20	754

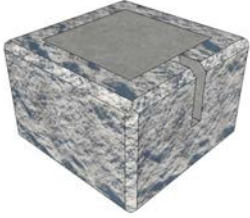
Column Block for Fence Rail - End			
Face Dimensions 16 in x 24 in			
			
Unit ID	Depth (in)	Volume (cf)	Weight (lb)
CBFRE	24	5.26	763

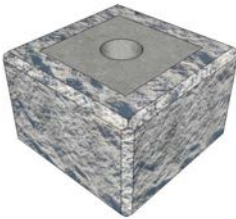
Column Block for Conduit / Reinforcement			
Face Dimensions 16 in x 24 in			
			
Unit ID	Depth (in)	Volume (cf)	Weight (lb)
CBCR	24	5.07	735

Column Cap			
Face Dimensions 6.5 in x 26 in			
			
Unit ID	Depth (in)	Volume (cf)	Weight (lb)
CC	26	2.54	368

Column Cap for Conduit			
Face Dimensions 6.5 in x 26 in			
			
Unit ID	Depth (in)	Volume (cf)	Weight (lb)
CCC	26	2.48	360

Textures

ReCon currently offers its licensed manufacturers a choice of five types of face textures. Most producers choose one of these textures as their standard and elect to maintain a working inventory of that texture. Other textures may still be available as a special-order. As with most special-order items, additional costs may be involved and sufficient time should be allowed for setup and production. Check with the ReCon licensed manufacturer in your market to determine what textures are available.

Le Sueur County Limestone

This texture offers the look of broken and weathered limestone and lends itself well to accent staining. When certain stain colors are used, Le Sueur County Limestone can also take on the appearance of a weathered sandstone material.

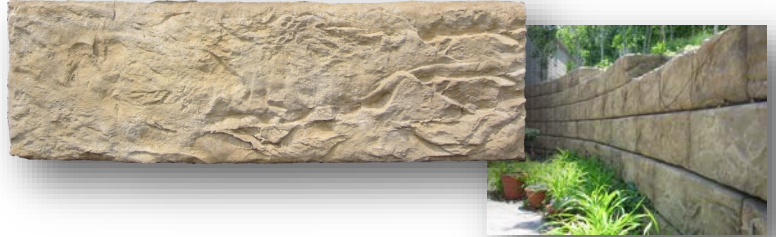

North Shore Granite

Granite may be the most recognized natural stone on earth. While its coloration varies widely, the texture of unprocessed granite is somewhat consistent in the way it fractures. Stained or unstained, the appearance of North Shore Granite is almost indistinguishable from weathered natural stone.



Old World

The Old World texture was originally developed as a special-order item to match the appearance of the popular cut stone building materials used in the late 1800's and early 1900's. Many different types of stone were used in this manner and the Old World texture can emulate most of them depending on the stains that are used. The face also lends itself to further processing, such as sand blasting or exposed aggregates.



Rustic

The Rustic texture captures the authenticity of a natural weathered cut stone that has been stacked in 8-inch coursing. The length of the individual stones varies from as little as 8-inches to as much as 26-inches, resulting in a natural random pattern.



Weathered Edge

With Weathered Edge, ReCon has carefully selected individual stones that offer depth and richness of texture and range of stone sizes. Stone heights range from 3 to 16-inches and widths range from 9 to 48-inches. The stones have been placed into a number of patterns that blend together to create an authentic and natural stone wall appearance.



Notes

A large grid of graph paper for taking notes, consisting of 20 columns and 30 rows of small squares.

Design Considerations

Retaining Walls

ReCon retaining walls are classified as Precast Modular Block Walls or PMBW. When designing a PMBW, it is critical that all of the appropriate information be gathered so that a proper design can be completed. At a minimum, the following information needs to be obtained:

- Wall Geometry – Including length, height, corners, curves, etc.
- Site Geometry – Wall surcharges, toeslopes, and backslopes and whether the wall is a cut or fill application.
- Soils Information – Retained soils, foundation soils, reinforced soils, etc.
- Project Specification – Design and project information and requirements.

Once this information has been collected, the designer can begin the design process. ReCon walls can be designed as either gravity retaining walls, which use the mass of the block to retain the soil, or as geogrid reinforced walls. **The ability to construct tall gravity walls is one of the key advantages of the ReCon retaining wall system.** Geogrid reinforced walls, also referred to as mechanically stabilized earth (MSE) walls, utilize layers of soil reinforcement between the block and in the area directly behind the retaining wall.



ReCon has several design tools to assist engineers in the analysis process. **ReConWall**, which is ReCon's proprietary analysis software, is a fully comprehensive retaining wall analysis tool available to industry engineers. In addition, ReCon has Wall Charts for both gravity and geogrid reinforced walls that demonstrate the general capabilities of the system. More information can be found on these and other tools later in this manual.

Finally, in many cases, special design considerations will arise that a designer will need to account for. Some of these considerations include, but are not limited to:

- Increased Wall Setback Options
- Retaining Walls in Water Applications
- Retaining Wall Drainage and Water Management
- Terraced Walls
- Global Stability

Each of these special design cases will be discussed in further detail within this manual.

Wall Geometry

For each ReCon retaining wall, the geometry will be dictated by the specifics of the project site and topography. Geometry for each wall generally consists of: wall length, wall height and the location of corners and curves. For most projects this information is found on the site-grading plan. A site-grading plan provides a tremendous amount of the information necessary to properly design a ReCon retaining wall.

For projects that don't have a formal site-grading plan, wall geometry is still required, even if perhaps obtained in a less formal way. Regardless of the source, this information is critical to proper design, determination of unit types, and the formulation of accurate unit quantities.

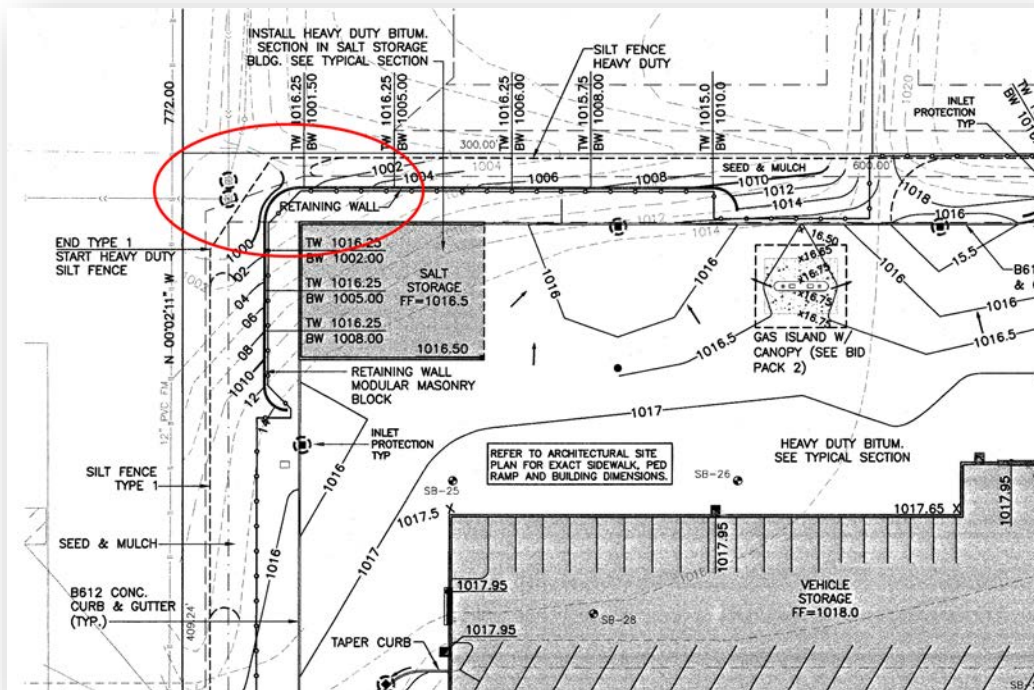

Site Geometry

In addition to wall heights, lengths, and layout, site-plans (grading plans) offer additional information about adjacent structures, surcharges, site access, property lines, utility locations and site drainage. All of these factors influence the final design and construction of a ReCon retaining wall.

Surcharges

When a retaining wall is exposed to additional loads, whether permanent or temporary, the overall wall design is affected and the loads will need to be accounted for. This is generally the case when the source of the load (building, roadway, sidewalk, etc.) is located within a distance from the face of the wall, that is less than twice the height of the wall. This is only a general rule based on the most common soil types. Wall design engineers must consider many other factors which may adjust this proximity formula.

Surcharges are usually classified as either temporary (live load) or permanent (dead load) and may stabilize or destabilize a wall, depending on their type and / or relative location with respect to the wall. An example of a live load might be a fully loaded semi-truck traveling along a roadway within close proximity to the top of the finished wall. Because this type of load is temporary, it only contributes to destabilizing forces and any stabilizing contribution of a live load is usually ignored.

A dead load, by contrast, is intended to be permanent. Although it will increase stresses on the wall, depending on its type and location, it can also contribute to certain aspects of wall stability. An example of a dead load may be a building constructed behind the wall which exerts additional weight through its foundation or footing.

Backslopes

A backslope is defined as an upward sloping grade at the top of a retaining wall. Backslopes are technically considered a soil dead load. Determining backslopes is completed during a review of the site-grading plan and inclusion of the backslope during the analysis process is critical.

Toeslopes

A toeslope is defined as a downward sloping grade at the face (or toe) of a retaining wall. Toeslopes are determined by examining the site-grading plan but in general do not increase or decrease the driving forces acting on the wall. They can, however, impact the overall Global Stability of the wall. Refer to the Global Stability section of this manual for additional information.

Cut or Fill Application

One of the final things determined regarding site geometry is whether the wall is a cut or fill application. Typically speaking, a cut wall is constructed to maximize the useable space at the bottom of the wall by cutting into an existing slope. By contrast, a fill wall maximizes the useable space at the top of the wall. Normally, a ReCon gravity wall will be best suited for cut wall applications and a ReCon geogrid reinforced wall will be best suited for fill wall applications. However, the use of wall type, gravity or geogrid reinforced, may vary depending on site conditions.

Soils Information

PMBWs, by definition, are a soil retention structures with a modular and mortar-less aesthetic facing. Since soil is one of the main components of the structure, it is necessary to know and understand the properties of these soils since they come in numerous types and compositions. For most projects, information regarding soil properties is obtained from a Geotechnical Report or Soil Boring Log. This information is then used in the wall analysis as well as to predict a wall's overall performance.

In the absence of detailed soils information, assumptions must be made about the soil properties in order to proceed. It is recommended that when assumptions are necessary, that they be generally conservative to preserve safety factors and wall integrity.

There are some soils that should never be used in the construction of a ReCon retaining wall. A detailed discussion of all soil types and properties is beyond the scope of this manual. The determination of a particular soil's suitability for use rightfully belongs within the realm of a trained and experienced civil or geotechnical engineer.

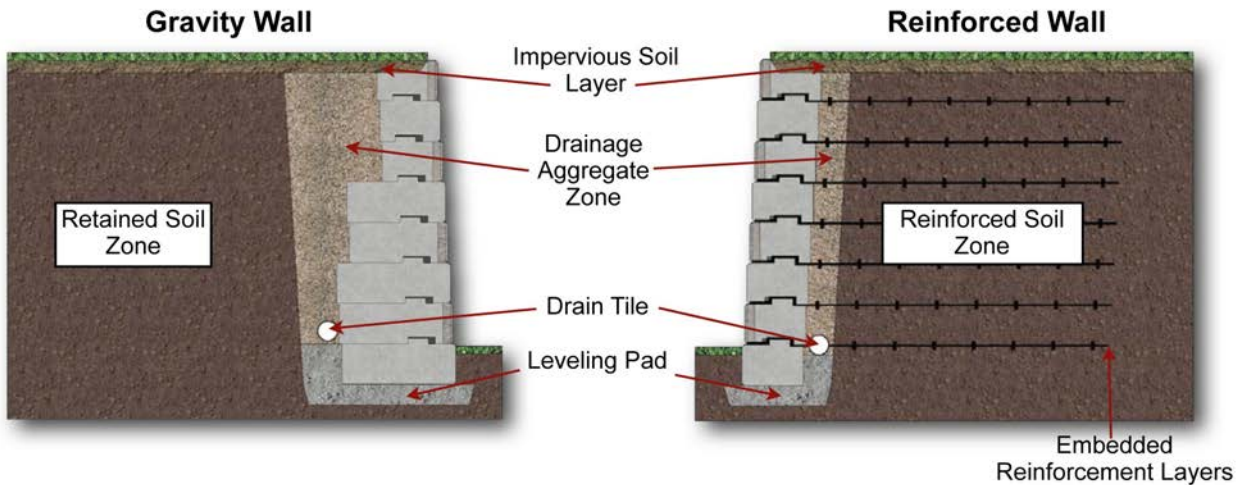

The soils that are of critical interest to a wall designer are categorized into five basic zones with respect to their location in and around the finished wall.

The **leveling pad** is not technically a soil zone, but is an integral part of a well-designed, well-built retaining wall. The leveling pad, located directly beneath the base block, should consist of well-graded granular material that allows for drainage but has enough fines to allow for proper compaction. Some examples of leveling pad material (by regional name) include: road base, class 5, $\frac{3}{4}$ -inch minus, and crush-and-run. The dimensions for the leveling pad vary and are discussed elsewhere in this manual.

The **drainage zone**, located within the voids between blocks and to a minimum depth of 1-foot behind the back of the units, is typically an imported, free-draining crushed rock material. This zone helps facilitate water flow to drainage collection pipes or dispersal areas. It is recommended that a generally self-compacting material, such as $\frac{3}{4}$ -inch crushed stone, be used as it eliminates the need to operate compaction equipment directly behind the wall facing.

The **foundation soil zone** is the area located beneath the ReCon blocks and drainage zone. This soil zone is responsible for providing adequate support for the weight of the retained wall above. In the case of a geogrid reinforced wall, the foundation soil zone extends beneath and behind the wall to a distance roughly equal to the depth of the embedded soil reinforcement.

The **reinforced soil zone** only applies to MSE walls and extends from the back of the drainage zone to the furthest extent of the geogrid soil reinforcement (tails of the grids). In some cases, this soil could be an on-site material. If this material is not suitable, then an imported, select fill material should be used. The properties of this material strongly influence the performance characteristics of the reinforced soil mass and, as such, have a significant effect on the strength, length and quantity of soil reinforcement in the design of the finished wall.

The **retained soil zone** is the material located behind the reinforced soil zone, in an MSE wall, or behind the drainage zone in a gravity retaining wall. Soil characteristics within this zone also have a significant effect on the design of the finished wall in the same way that the reinforced soil zone does.

Project Specification

The purpose of a project specification is to outline specific requirements regarding materials, products, installation procedures, design guidelines and quality aspects. As a wall designer, this document should be used to determine required design methodologies, submittals, and other project specific requirements. For wall specifiers, an example of a project specification for ReCon is located at the end of this manual and is available for use. Visit www.reconwalls.com to obtain a copy.

ReConWall Analysis Software

ReConWall is ReCon's proprietary retaining wall analysis software that is available to industry professionals and wall design engineers. This powerful and easy to use software allows the user to analyze both gravity and geogrid reinforced wall sections. Here are just a few of the software's enhanced and comprehensive features:

- NCMA, AASHTO and CSA Design Methodologies
- Water Analysis – Buoyancy and Rapid Drawdown
- Global Stability Analysis
- Seismic Analysis
- Inputs for multiple soil zones
- Inputs for surcharge loading, backslopes and toeslopes
- Full calculation print-out
- Extensive User Help Manual

To obtain a copy of ReConWall, please visit www.reconwalls.com.

The image displays two screenshots of the ReCon Analysis Software interface. The left screenshot shows the 'Project Information' dialog box, which includes fields for Date, Project, Owner, Client, Site Designer, Designer, Location, Block type, and Geogrid Type. The right screenshot shows the 'Results' window, which includes a table of forces and moments, a diagram of a retaining wall section, and a summary of results including FOS values and bearing capacity.

Name	Elev (appt)	ia	Pa	Pac	Pasp	Pat	FSs(V/P)	FOS QT	%DR
TC	10.64(1.36)	0.273	20	0	0	0	100.00	27.72	150%
24	9.3(2.66)	0.273	116	0	0	0	118	62.37	74%
24	7.98(2.02)	0.273	264	0	0	0	264	28.54	3.60
24	6.62(1.68)	0.273	468	0	0	0	468	18.48	2.13
39	5.26(1.35)	0.256	958	0	0	0	959	9.62	2.72
39	3.90(0.91)	0.242	1310	0	0	0	1310	7.12	2.10
29	2.60(0.24)	0.231	1734	0	0	0	1734	5.53	1.68
45	1.33(0.07)	0.245	2355	0	0	0	2355	4.38	1.58
60	0.01(2.00)	0.287	2342	0	0	0	2342	1.80 (1.71)	1.80

Results Recalc
FOS Overturning = 1.26...OK
FOS Sliding = 1.86/1.71...OK (base / foundation)
Bearing = 2775.86...OK (Out/FSBv. 3005.65)
FOS Bearing = 2.17
Length = 5.00
L/H = 41.7%

ReCon Wall Charts

ReCon's Wall Charts have been prepared to demonstrate the capabilities of the ReCon Wall System in a variety of assumed conditions. Wall Charts have been provided for both Gravity Retaining Walls as well as Geogrid Reinforced Walls using the loading assumptions shown in the figures below. A number of assumptions have been made in the preparation of the charts. It is important to read the notes to understand these assumptions. These wall charts are not intended for construction or bidding purposes. All wall sections should be designed by a Professional Engineer that is familiar with the project, using site specific conditions.

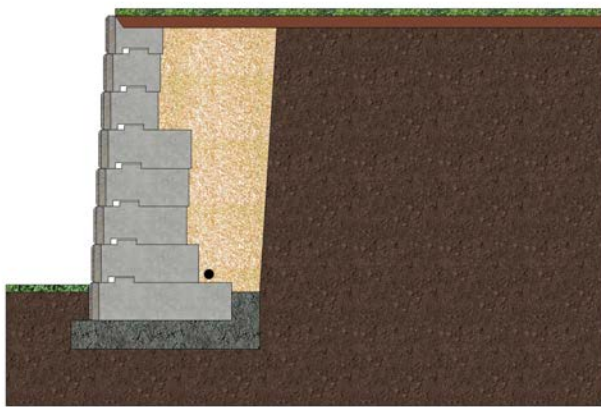

Level Backslope — No Surcharge

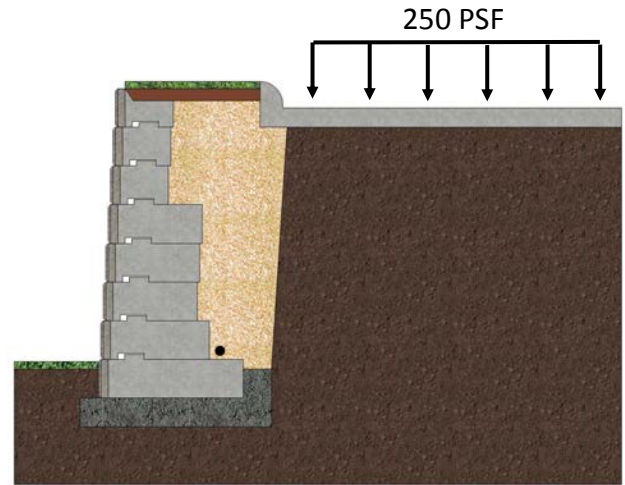

Level Backslope — 250 PSF Surcharge

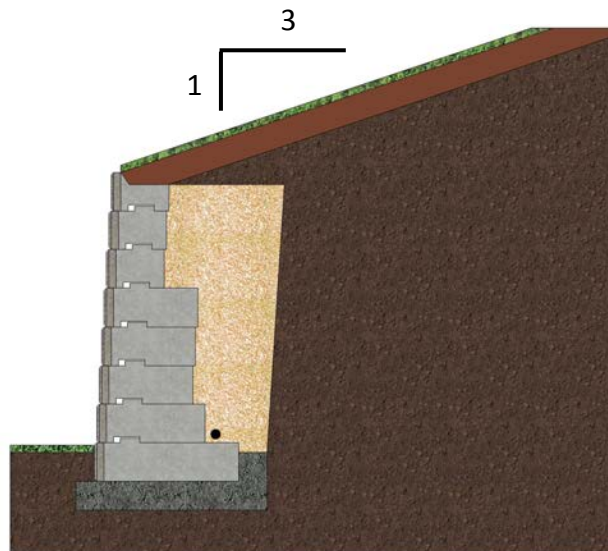

3H:1V Backslope—No Surcharge

Disclaimer: The ReCon Wall Charts were prepared by ReCon Wall Systems, Inc. and to the best of ReCon's knowledge accurately represent the product use in the application illustrated. These charts are for conceptual and instructional purposes only. Anyone making use of these charts does so at their own risk and assumes all liability for such use. Final design, for construction purposes, must be done by a registered Professional Engineer who is familiar with the project and who has considered the specific site conditions. These charts should be used in conjunction with all of the stated notes and cross section information.

Typical Gravity Wall Cross Section

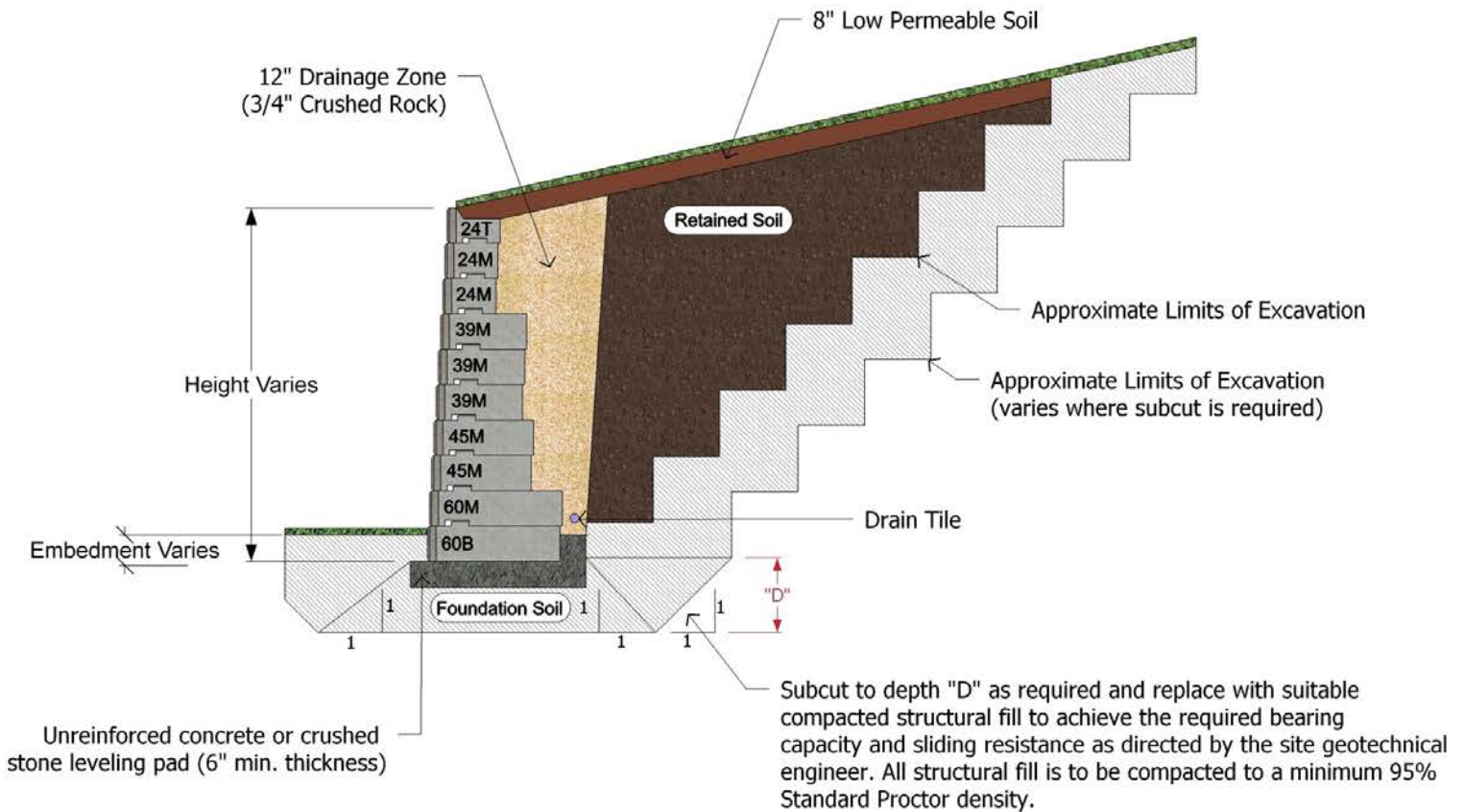

Notes: Typical Gravity Wall Cross Section

1. Wall height is the total height from top of leveling pad to top of wall.
2. Minimum wall embedment is typically 6-inches or 5% of the total wall height, whichever is greater (walls with a level toeslope). Refer to ReCon's Embedment Recommendation document for additional information for walls with a toeslope condition.
3. Leveling pad material assumed to have an internal frictional angle equal to 40-degrees.
4. Subsurface material (foundation soils) shall be capable of supporting the wall system.
5. Finished grade at top and bottom of wall shall provide positive drainage.
6. Drainage zone material shall be free-draining granular material such as ¾-inch crushed stone.
7. All retained backfill materials shall be compacted to a minimum 95% standard proctor density.

Notes: Gravity Wall Charts

1. The gravity wall charts have been prepared with calculations that utilize both the horizontal and vertical components of Coulomb earth pressure.
2. NCMA minimum factors of safety for overturning, sliding and bearing are 1.5, 1.5, and 2.0 respectively. AASHTO minimum factors of safety for overturning, sliding and bearing translate to 2.0, 1.5, and 3.0 respectively. The selection of the appropriate factors of safety should be based on the certainty with which design parameters and the consequences of failure are known.
3. The values shown in these charts reflect minimum factors of safety for overturning, sliding and bearing of 1.5, 1.5, and 2.0 respectively.
4. Sliding has been calculated between the base block and the leveling pad as well as between the leveling pad and foundation soils.
5. Global stability has not been addressed in preparation of these charts.
6. The values shown in the charts assume that the phi angle is the same for both the foundation and the retained soils and that both soils have a unit weight of 120 pcf.
7. Installation shall follow ReCon's installation instructions and any additional instructions or guidance provided as a part of the final engineered stamped and site specific plans.

ReCon Gravity Wall Charts

3.6-degree Batter - 1-inch Setback per Block Course

Silt/Lean Clay - Phi = 26-Degree

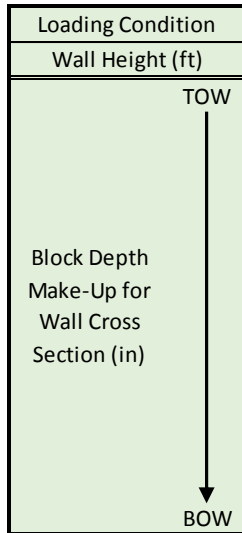

Level Backslope		
5.33	12.00†	17.33†
24	24	24
24	24	24
24	24	24
24	24	24
	39	39
	39	39
	45	45
	45	45
	60	60
		60
		66
		78
		84

250 PSF Surcharge††		
5.33	12.00†	16.00†
24	24	24
24	24	24
24	24	24
24	24	24
39	39	39
	39	39
	39	39
	60	60
	60	60
	78	60
		72
		78
		84

3H:1V Backslope†††		
5.33	12.00†	16.00†
24	24	24
24	24	24
24	24	24
39	39	39
	39	39
	39	39
	45	45
	60	60
	78	60
		84

Sand/Gravel - Phi = 34-Degree

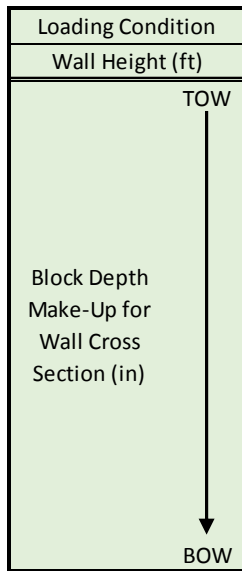

Level Backslope		
5.33	12.00	18.67
24	24	24
24	24	24
24	24	24
24	24	24
	39	39
	39	39
	45	45
	45	45
	60	60
		60
		66
		72
		78
		84

250 PSF Surcharge††		
5.33	12.00	17.33
24	24	24
24	24	24
24	24	24
24	24	24
24	24	24
	39	39
	39	39
	39	39
	45	45
	60	60
	60	60
		60
		72
		78
		84

3H:1V Backslope†††		
5.33	12.00	17.33
24	24	24
24	24	24
24	24	24
24	24	24
	39	39
	39	39
	39	39
	45	45
	45	45
	60	60
		60
		72
		78
		84

- † Wall embedment and leveling pad thickness increased beyond minimums shown on previous page in order to increase sliding resistance and/or bearing capacity
- †† 250 PSF surcharge is offset 3-feet from the back of the top block
- ††† 3H:1V backslope is measured from the back of the top block

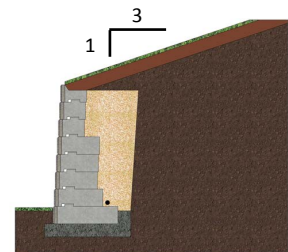
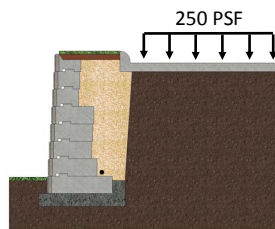
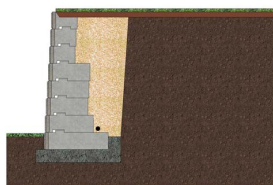

Typical Geogrid Reinforced Wall Cross Section

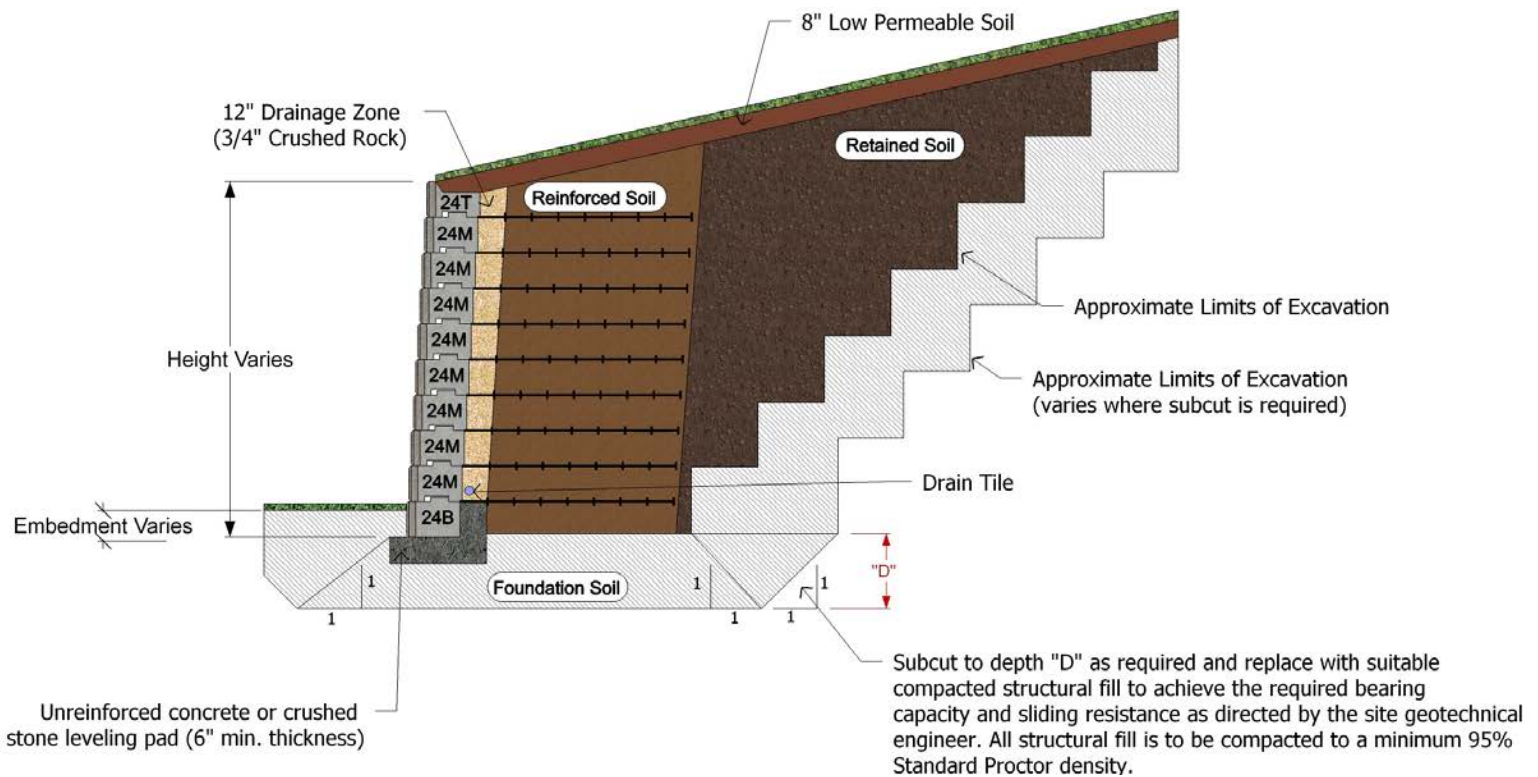

Notes: Typical Geogrid Reinforced Wall Cross Section

1. Wall height is the total height from top of leveling pad to top of wall.
2. Geogrid length is measured from the front face of the block.
3. Minimum wall embedment is typically 6-inches or 5% of the total wall height, whichever is greater (walls with a level toeslope). Refer to ReCon's Embedment Recommendation document for additional information for walls with a toeslope condition.
4. Leveling pad material assumed to have an internal frictional angle equal to 40-degrees.
5. Subsurface material (foundation soils) shall be capable of supporting the wall system.
6. Finished grade at top and bottom of wall shall provide positive drainage.
7. Drainage zone material shall be free-draining granular material such as ¾-inch crushed stone.
8. All reinforced and retained backfill materials shall be compacted to a minimum 95% standard proctor density.

Notes: Geogrid Reinforced Wall Charts

1. The Geogrid Reinforced wall charts have been prepared per the NCMA Design Manual for Segmental Retaining Walls – 3rd Edition.
2. The values shown in these charts reflect minimum factors of safety for overturning, sliding and bearing of 1.5, 1.5, and 2.0 respectively. Additionally, a factor of safety of 1.5 has been used for geogrid strength, connection and pullout.
3. Values in the charts assume a minimum long-term allowable geogrid design strength of 2,500 pounds per foot.
4. Global stability has not been addressed in preparation of these charts.
5. The values shown in the charts assume that the phi angle is the same for the foundation, reinforced and retained soils. All soils are assumed to have a unit weight of 120 pcf.
6. Installation shall follow ReCon's Installation Instructions and any additional instruction or guidance provided as a part of the final engineered stamped and site specific plans.

ReCon Geogrid Reinforced Wall Charts

3.6-degree Batter - 1-inch Setback per Block Course
Flat Backslope—No Surcharge

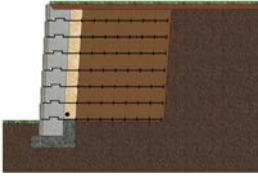

Minimum Required Geogrid Lengths by Elevation (ft)

		Wall Height (ft)									
		8.00	9.33	10.67	12.00	13.33	14.67	16.00	17.33	18.67	20.00
Soil Phi Angle = 26-degree	Grid Elevation (ft)										
	18.67										17
	17.33									16	-
	16.00								15	-	17
	14.67							15	-	16	-
	13.33						14	-	15	-	17
	12.00					13	-	15	-	16	-
	10.67				12	-	14	-	15	-	17
	9.33			11	-	13	-	15	-	16	-
	8.00		10	-	12	-	14	-	15	-	17
	6.67	9	-	11	-	13	-	15	-	16	17
	5.33	-	10	-	12	-	14	-	15	16	17
4.00	9	-	11	-	13	-	15	15	16	17	
2.67	-	10	-	12	-	14	15	15	16	17	
1.33	9	-	11	-	13	14	15	15	16	17	
Soil Phi Angle = 30-degree	18.67										16
	17.33									15	-
	16.00								14	-	16
	14.67							13	-	15	-
	13.33						13	-	14	-	16
	12.00					11	-	13	-	15	-
	10.67				11	-	13	-	14	-	16
	9.33			10	-	11	-	13	-	15	-
	8.00		9	-	11	-	13	-	14	-	16
	6.67	8	-	10	-	11	-	13	-	15	-
	5.33	-	9	-	11	-	13	-	14	-	16
	4.00	8	-	10	-	11	-	13	-	15	16
2.67	-	9	-	11	-	13	-	14	15	16	
1.33	8	-	10	-	11	-	13	14	15	16	
Soil Phi Angle = 34-degree	18.67										14
	17.33									14	-
	16.00								13	-	14
	14.67							12	-	14	-
	13.33						11	-	13	-	14
	12.00					11	-	12	-	14	-
	10.67				10	-	11	-	13	-	14
	9.33			9	-	11	-	12	-	14	-
	8.00		8	-	10	-	11	-	13	-	14
	6.67	7	-	9	-	11	-	12	-	14	-
	5.33	-	8	-	10	-	11	-	13	-	14
	4.00	7	-	9	-	11	-	12	-	14	-
2.67	-	8	-	10	-	11	-	13	-	14	
1.33	7	-	9	-	11	-	12	-	14	14	

ReCon Geogrid Reinforced Wall Charts

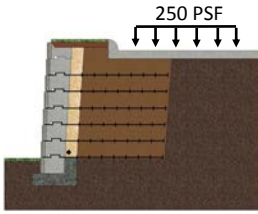

3.6-degree Batter - 1-inch Setback per Block Course
 Flat Backslope—250 PSF Surcharge (3-feet from back of Wall)

Minimum Required Geogrid Lengths by Elevation (ft)

		Wall Height (ft)										
		8.00	9.33	10.67	12.00	13.33	14.67	16.00	17.33	18.67	20.00	
Soil Phi Angle = 26-degree	Grid Elevation (ft)											
	18.67											19
	17.33									18		-
	16.00								17			19
	14.67							16				-
	13.33						15					19
	12.00					14						-
	10.67				13							19
	9.33			12								19
	8.00		11									19
	6.67	10										19
	5.33		11									19
	4.00	10										19
2.67		11									19	
1.33	10										19	

Soil Phi Angle = 30-degree	18.67											16
	17.33										16	-
	16.00								15			16
	14.67							14				-
	13.33						13					16
	12.00					12						-
	10.67				11							16
	9.33			10								-
	8.00		9									16
	6.67	9										16
	5.33		9									16
	4.00	9										16
	2.67		9									16
1.33	9										16	

Soil Phi Angle = 34-degree	18.67											15
	17.33										14	-
	16.00									13		15
	14.67							12				-
	13.33						12					15
	12.00					11						-
	10.67				10							15
	9.33			9								-
	8.00		9									15
	6.67	8										-
	5.33		9									15
	4.00	8										-
	2.67		9									15
1.33	8										15	

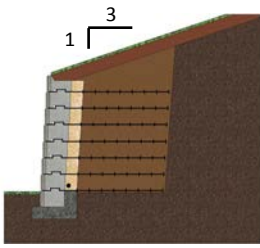

ReCon Geogrid Reinforced Wall Charts

3.6-degree Batter - 1-inch Setback per Block Course
3H:1V Backslope—No Surcharge

Minimum Required Geogrid Lengths by Elevation (ft)

		Wall Height (ft)									
		8.00	9.33	10.67	12.00	13.33	14.67	16.00	17.33	18.67	20.00
Soil Phi Angle = 26-degree	Grid Elevation (ft)										
	18.67										22
	17.33									21	-
	16.00								19	-	22
	14.67							18	-	21	-
	13.33						17	-	19	-	22
	12.00					15	-	18	-	21	22
	10.67				14	-	17	-	19	21	22
	9.33			13	-	15	-	18	19	21	22
	8.00		11	-	14	-	17	18	19	21	22
	6.67	10	-	13	-	15	17	18	19	21	22
	5.33	-	11	-	14	15	17	18	19	21	22
	4.00	10	-	13	14	15	17	18	19	21	22
2.67	-	11	13	14	15	17	18	19	21	22	
1.33	10	11	13	14	15	17	18	19	21	22	

Soil Phi Angle = 30-degree	18.67										19
	17.33									18	-
	16.00								17	-	19
	14.67							16	-	18	-
	13.33						14	-	17	-	19
	12.00					13	-	16	-	18	-
	10.67				12	-	14	-	17	-	19
	9.33			11	-	13	-	16	-	18	19
	8.00		10	-	12	-	14	-	17	18	19
	6.67	9	-	11	-	13	-	16	17	18	19
	5.33	-	10	-	12	-	14	16	17	18	19
	4.00	9	-	11	-	13	14	16	17	18	19
	2.67	-	10	-	12	13	14	16	17	18	19
1.33	9	-	11	12	13	14	16	17	18	19	

Soil Phi Angle = 34-degree	18.67										17
	17.33									16	-
	16.00								15	-	17
	14.67							14	-	16	-
	13.33						13	-	15	-	17
	12.00					12	-	14	-	16	-
	10.67				11	-	13	-	15	-	17
	9.33			10	-	12	-	14	-	16	-
	8.00		9	-	11	-	13	-	15	-	17
	6.67	8	-	10	-	12	-	14	-	16	-
	5.33	-	9	-	11	-	13	-	15	-	17
	4.00	8	-	10	-	12	-	14	-	16	17
	2.67	-	9	-	11	-	13	-	15	16	17
1.33	8	-	10	-	12	-	14	15	16	17	

Multiple Setback Options

The ability to design a gravity wall to heights reaching 20-feet and beyond can help solve even the most complex site challenges and add significant value. This is especially true in cut wall applications when the objective is to maximize the useable space at the base of the wall. ReCon gravity walls can be designed using a smaller footprint than geogrid reinforced walls, which require grids to be at least 60% of the height of the wall. Therefore, gravity walls maximize usable space and save on excavation and construction costs.

In design, the achievable height of a gravity wall can be increased by (a) increasing the depth of the blocks, or (b) increasing the batter / setback of the wall. ReCon's retaining wall block lineup has a standard, industry leading, **EIGHT** block depths. Each of the blocks is produced with an integrated block-to-block tongue and groove system that creates 1-inch of setback per course. In addition, ReCon offers two options for increasing the batter of the wall by modifying the setback between the individual blocks. These options include:

1. Adding a 1-inch fiberglass spacer bar (available from ReCon) along the back of the tongue, effectively doubling the batter of the wall from 3.6 to 7.2-degrees. This quick modification is completed by the contractor in the field. Use of the spacer bar is recommended for walls 13-feet 4-inches in height or less.
2. Using ReCon Channel Block, which increases the setback between courses from 1-inch to 8-inches, resulting 26-degrees of wall batter. ReCon Channel Block achieves this additional batter through an alternate tongue and groove system that is integrated into the form during the production process.

Check with the local ReCon Licensed Producer for availability of the Channel Block in each particular market since it is not generally stocked as an inventory item.

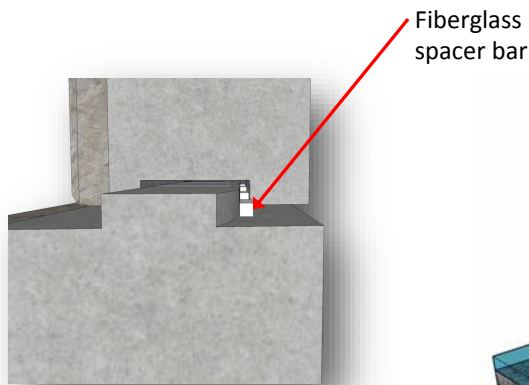

Spacer Bar Option

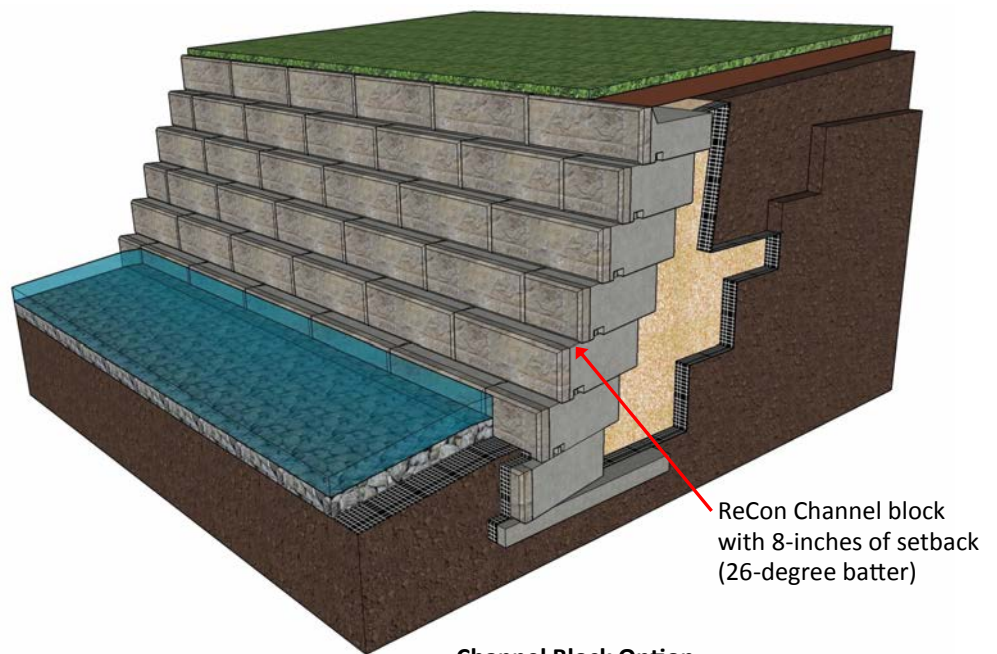

Channel Block Option

Water Applications

ReCon blocks have quickly become the product choice for retaining wall water applications because of their proven durability and ease of installation. By using wet-cast, air-entrained concrete, ReCon blocks can perform in numerous harsh environments, including exposure to chlorides, exposure to repeated freeze thaw cycles, and water submerged applications. Since ReCon blocks do not require steel reinforcement, they are not susceptible to the effects of corrosion. In addition, ReCon blocks allow for rapid installation and reduce the footprint when constructed as a gravity wall.

Special consideration should be taken when designing a retaining wall for a water application. Water has a significant impact on the bearing capacity of soils, the magnitude of driving forces and the calculation of resisting weights. It is recommended that wall designers utilize ReCon's wall analysis software, ReConWall, when completing the design of a water application retaining wall. The figure below shows some of the specific construction requirements for water application walls. Additionally, designers should refer to ReCon's Typical Construction Details regarding water application for specific construction recommendations and requirements. Visit www.reconwalls.com for additional information.

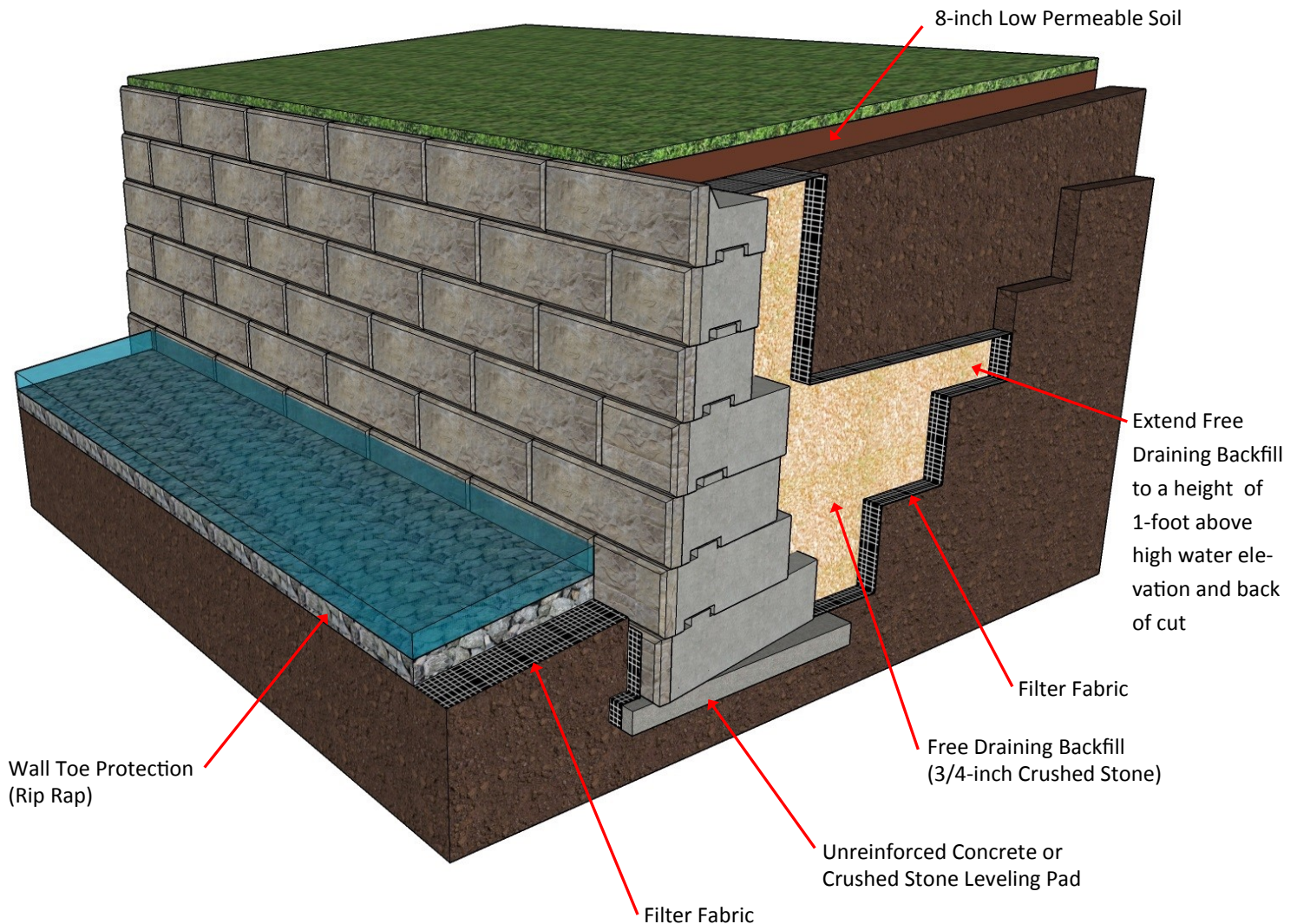

Drainage and Water Management

Most performance issues associated with PMBWs can be traced back, directly or indirectly, to water. The presence of water behind a retaining wall, whether it is anticipated or not, affects soil mechanics and increases wall stress. Additionally, a high-water table can weaken foundation soils to the point where they can no longer support the wall. Moving water over the top or along the bottom of a finished wall can erode the soil at the toe causing the wall to become unstable and needing to be rebuilt. For these reasons, it is critical that drainage and water management be considered prior to, during, and after a wall is constructed. In construction, the project site is continually changing. Consequently, drainage and water management techniques may change or need to be modified during the construction process.

Proper drainage and water management considers water from all directions. Where the water originates from will dictate the best method for moving or removing the water from the areas that may adversely affect wall performance. This may be completed through drainage columns, pipes, blankets or specifying a specific backfill material. A number of these features can be seen in the figure shown below. For more information please refer to ReCon's Typical Construction Details regarding drainage and water management which can be found at www.reconwalls.com.

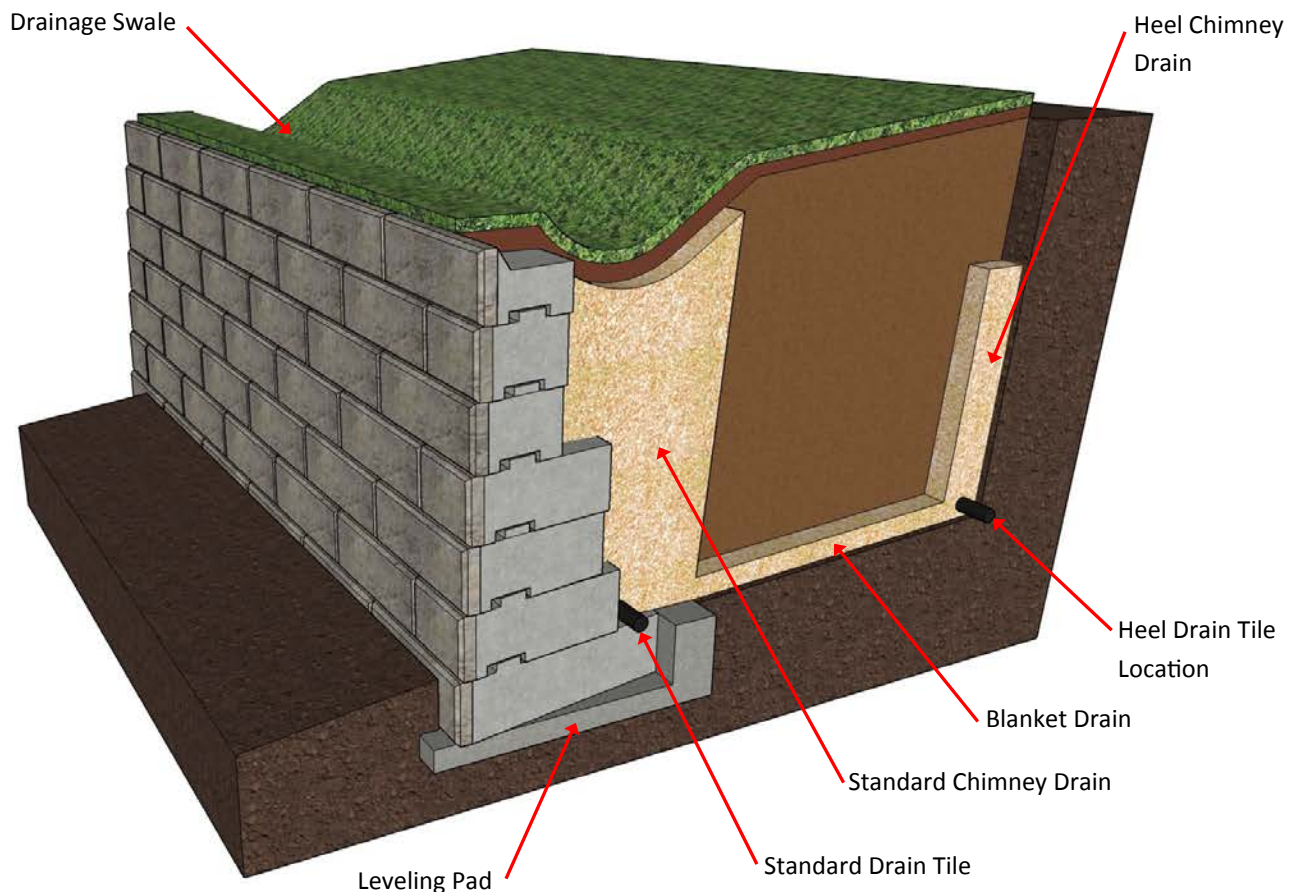

Terraced Walls

Terraced walls are a common feature in retaining wall applications. From an engineering standpoint, these walls must be treated as a single composite structure if their proximity, in conjunction with other site and soil parameters, is such that an upper wall places additional load or stress on the wall (or walls) below.

Most terraced walls may be considered independent of each other if they meet the requirements of the following general rule:

Terraced Wall “2:1” General Rule

“Terraced walls are generally considered independent of each other if... 1) the height of the upper wall is less than or equal to the height of the lower wall and ... 2) the distance between the two walls is at least twice the height of the lower wall.”

This general rule may not apply if soils are very poor, if toeslopes or backslopes are involved, or if there are additional surcharges present. Terraced walls that do not meet the “2:1” rule usually require additional mass and / or soil reinforcement incorporated into the lower wall design to resist the additional stress applied by the upper wall.

Regardless of whether terraced walls are determined to be independent, based upon the rule above, it is recommended that an overall global stability calculation be completed for the system of walls as this may control some of the design aspects.

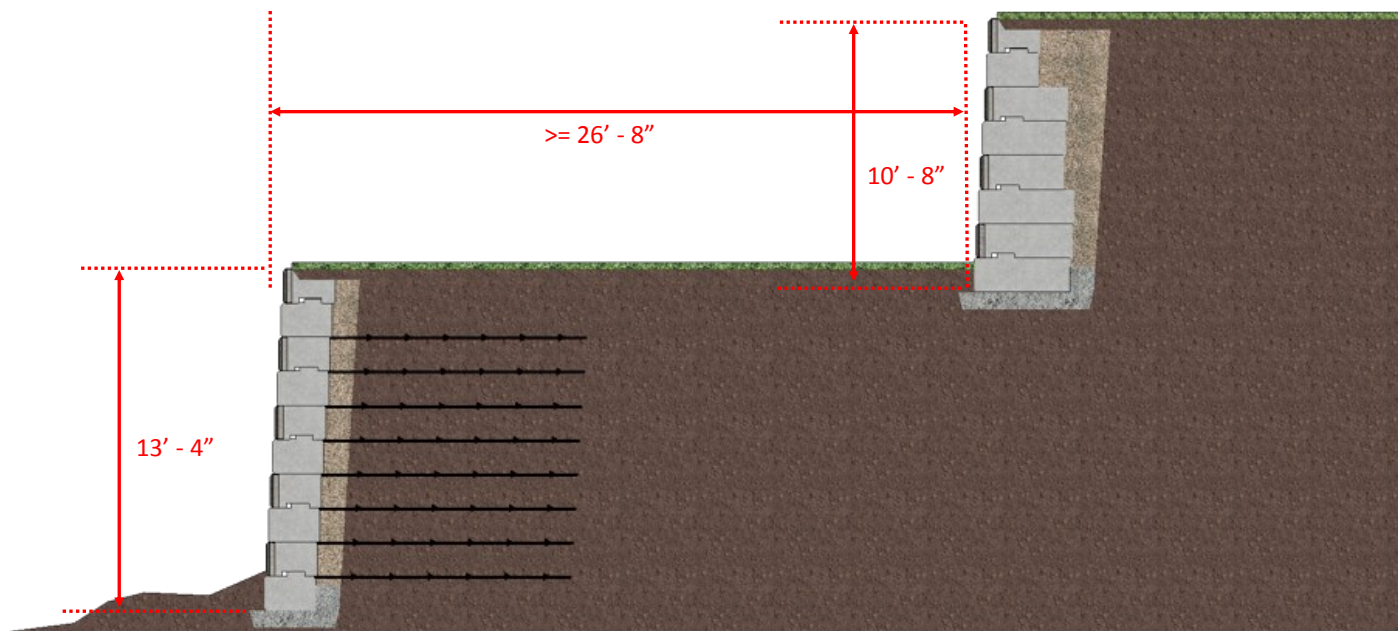

Terraced Wall Example

Global Stability

Global stability is defined as rotational, general mass movement of a retaining wall and the adjacent soils. Over the years, several analysis methods and tools have been developed for analyzing global stability. ReConWall, which is ReCon's proprietary wall analysis software, is just one tool that designers have access to that can aid in the analysis process. In analysis, numerous soil failure planes, passing behind and beneath the wall, are considered to determine the most critical path. Based upon this critical path, a factor of safety is determined. To learn more about ReConWall's approach to global stability analysis, refer to the software's User Help Manual.

Global stability is an important component in retaining wall design and should always be considered during the analysis process. It becomes increasingly important in the presence of any of the following site conditions:

- Walls with toeslopes and/or backslopes
- Walls with significant surcharge loading
- Walls subjected to seismic loading
- Water application walls
- Walls constructed in poor soil conditions (soft soils, organics, high plasticity clays, etc.)
- Terraced walls
- Or any combination of the above

As previously mentioned, ReConWall is powerful tool for analyzing global stability for simple wall geometries, which includes many of the conditions noted above. For complex geometries though, such as terraced walls or multiple toe and back slopes, it is recommended that a third-party software be used that is capable of modeling these conditions.

ReCon Analysis Software, version 4.0.16053

File Edit Window Help

Section 1 Update Design Move All Geogrids Up Down Draw Bearing Text

Global Stability
STATIC ANALYSIS

Compound Stability --- Safety Map
Global Stability 1.458 Safety Map

Draw Slices
 AASHTO / NCMA Methods
% Rotation 100
 No Reinforcing
 No Facing
ReDraw Image
Zoom 0.99 Refresh
 Force Limited Search
Enter Pt From -1 To 100
Exit Pt -1 100
Radius -1 100
Search Increments 1
Point Increments 20 %
Depth of Search 2 xH

Graphic Compound Results Global Results Compound Slices Global Slices

FS > 2
1.5 - 2
1.4 - 1.5
1.3 - 1.4
FS < 1.3
Internal
FS < 1.5

FS = 1.458

24
24
24
39
39
60
72

DISCLAIMER: This software is for initial estimating purposes only. Do not use for final design or construction without the review of a professional engineer. Retain a professional engineer to design every wall on a case-by-case basis using the site specific criteria. The accuracy and use of this document are the sole responsibility of the user. All calculations were performed based on the NCMA or AASHTO design methodologies using factor of safety accepted by the industry.

Design Units = US Design Method

Independent Pedestrian Railings, Fences and Traffic Barriers

Often, it is desired or required that an independent pedestrian railing, fence or traffic barrier be constructed behind the top of a finished retaining wall. Although they are technically independent from a construction perspective, it is possible that any load applied to these structures could influence the wall. For that reason, it is important that the wall design engineer and the railing/fence/traffic barrier engineer coordinate efforts to ensure that both designs are adequate.

Additional information regarding typical loading for pedestrian handrails, fences and traffic barriers is discussed in subsequent sections of this manual.

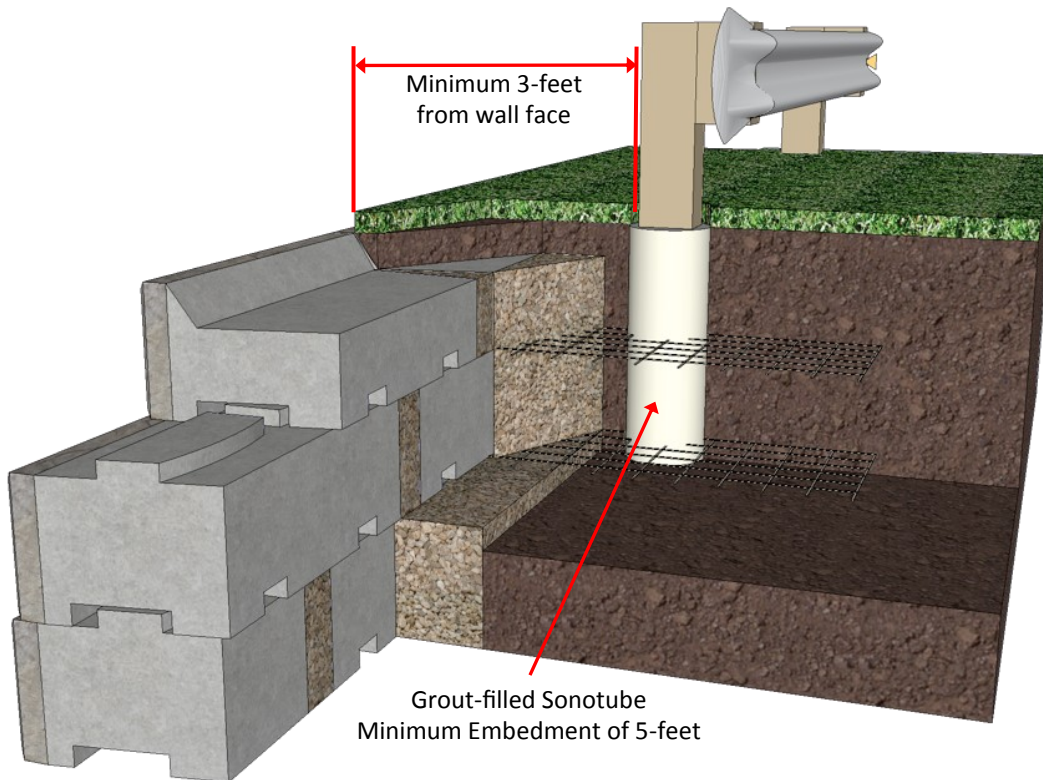

Notes:

1. The figure above is intended to visually depict some of the minimum construction requirements for installing an independent post and beam traffic barrier. These minimums are based upon the requirements of the AASHTO LRFD Bridge Design Specification. Final design of the post and beam system, including the depth and diameter of the required Sonotube and the distance from face of wall is by others.
2. Once the final design of the post and beam system is determined, the wall design engineer should verify that the retaining wall design is capable of resisting any induced load from impact on the traffic barrier.
3. For ReCon walls requiring geogrid reinforcement, refer to the Construction portion of this manual for additional guidance on the installation of the Sonotube.

Integral Pedestrian Railings and Fences

One of the defining characteristics of ReCon blocks is their substantial mass. Among many other advantages, the mass of the blocks presents an ideal condition for safely mounting pedestrian railings and fence posts directly to the top of the blocks.

When analyzing ReCon blocks for the addition of handrailings or fences, there are several loads that need to be considered. These include pedestrian load, wind load, earth load or a combination of the three. The magnitude of these loads is typically determined in accordance with Code and project requirements. For more information regarding these loads, refer to the International Building Code (IBC), American Society of Civil Engineer (ASCE) 7, and the American Association of State Highway and Transportations Officials (AASHTO) Bridge Design Specification.

In some cases, the mass of a single block is adequate to resist the overturning forces from the applied loads. In other applications, the mass of more than one block is required. In these instances, a mechanical connection between blocks is required. ReCon has a spreadsheet calculator that is setup to help determine the block configuration that is required based upon specific conditions. Block configurations may consist of ReCon's Top Block, Full-High Cap, or Fence Block and Capstone. Additionally, the calculator provides some general guidance on the loading that the system must be designed for. Please contact ReCon to obtain a copy of this calculator. The figures below illustrate two options for attaching a fence or railing post to a ReCon Top Block. Refer to ReCon's Typical Construction details for additional information on mechanically fastening multiple courses of block.

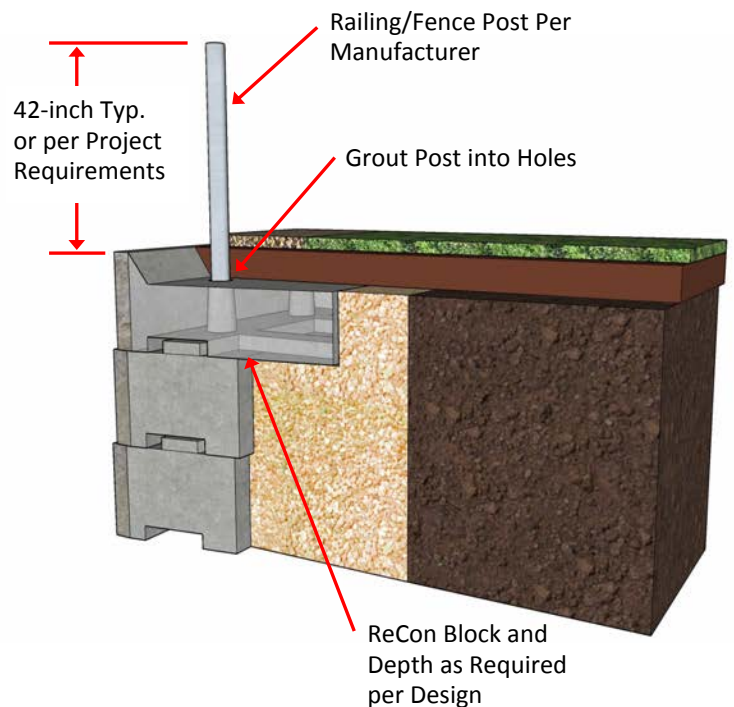
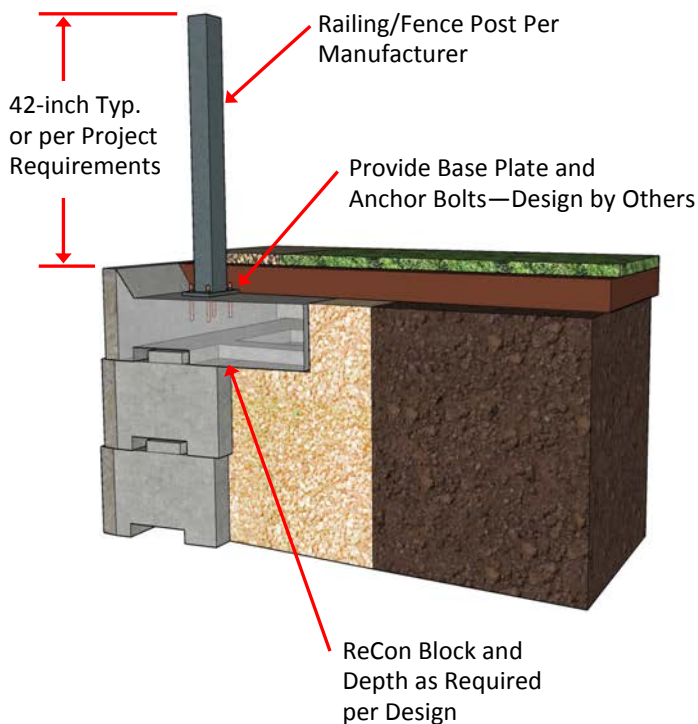

Fence and Guardrail Block Walls

In addition to the full offering of retaining wall blocks, ReCon offers a variety of Fence and Guardrail blocks. Fence and Guardrail blocks are used in above grade applications and are textured on all exposed faces. So, whether your project needs a free-standing wall or an above grade option to complement our traditional retaining wall blocks, the Fence and Guardrail blocks offer an excellent solution.

Independent and Integral Free-Standing Walls

Whether completely independent, or constructed at the top of a retaining wall, ReCon's free-standing Fence block provides a unique solution when a project requires a privacy barrier with the look of natural stone.

Although each of ReCon's Fence blocks have considerable mass, there are limitations to the height in which they can be stacked without the need for reinforcement securing the block together. In a report dated December 2, 2005, Ericksen Roed & Associates summarizes the results of an engineering analysis that was completed for ReCon's free-standing Fence block system. The purpose of the analysis was to determine the structural capacity of a free-standing wall with respect to lateral forces applied above grade. The wall was analyzed using the following loads:

1. A continuous pedestrian load of 50 pounds per linear foot, applied horizontally at a height of 42-inches above grade, per the International Building Code 2000 (IBC) 1607.7.1
2. A single pedestrian load of 200 pounds, applied at any point, per IBC 1607.7.1.1
3. A wind pressure of 15 pounds per square foot, per IBC 1609.1.2

The critical load combination was determined to be the continuous load (50 lb/ft) acting in conjunction with 80% of the prescribed wind pressure. The results of the analysis show that a free-standing wall can be stacked to a **maximum height of 6-feet 8-inches above grade** and still meet minimum factors of safety. Above this height, the need for reinforcement and a wider footing would be required. In cases where reinforcement is required, it is recommended that ReCon's Guardrail block be used, to help facilitate and ease installation. To obtain a copy of the full analysis and report, please contact ReCon Wall Systems.

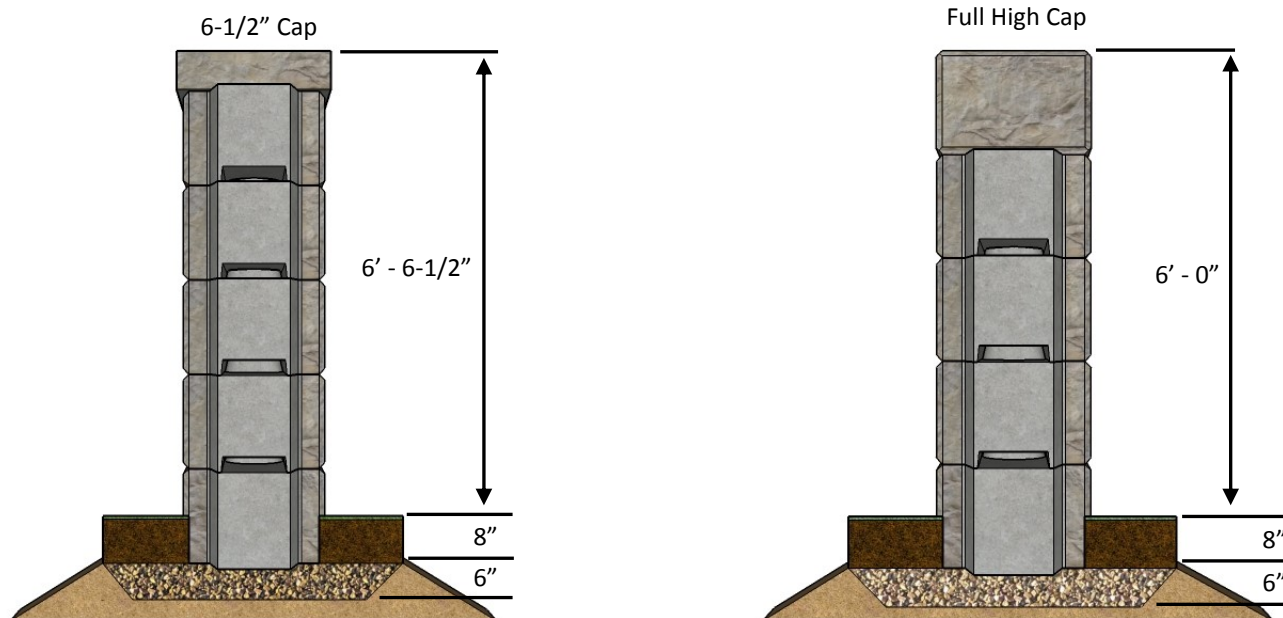

When constructing an independent, free-standing wall using ReCon Fence block it is important that the foundation soils be properly prepared and compacted to provide adequate support for the wall. When free-standing walls are installed in combination with a retaining wall (as the top of wall finish), the wall and foundation soils should be analyzed for the addition of the free-standing wall's weight.

Integral Traffic Barrier

Often times, in the case of parking lots and along roadways, there is not enough space to install an independent traffic barrier system behind the top of wall. In these situations, a traffic barrier can be created at the top of a ReCon retaining wall using ReCon's Guardrail block.

There are many things that must be considered when designing a traffic barrier system. The most important piece of information though, is the magnitude of force that the barrier must be capable of resisting. This force is often referred to as an impact load, but in design it is common to use an equivalent static load. Both the International Building Code (IBC) and the American Association of State Highway and Transportation Officials (AASHTO) Bridge Design Specification provide guidance on determining applicable loads.

The IBC has a standard load, equal to 6,000 pounds, that is for vehicle barriers in parking structures or intended to protect building elements. This load is also generally accepted for parking lots, residential side streets or private drives where low vehicle speeds are anticipated.

By contrast, the AASHTO Standard has six load levels ranging from Test Level-1 (TL-1) through TL-6. Each of these load levels corresponds to a maximum vehicle mass, speed and angle of impact to the barrier. This information is then used to calculate an equivalent static load that can be used in design. For TL-1, that load is 13,500 pounds.

With proper reinforcing and block depths, ReCon's Guardrail block can be used to create a traffic barrier capable of resisting loads as high as AASHTO's TL-1. The figure below shows the general configuration of the block as well as the location of the rebar reinforcement. Please contact ReCon Wall Systems to obtain a copy of the supporting calculations for both the IBC and the AASHTO TL-1 traffic barriers.

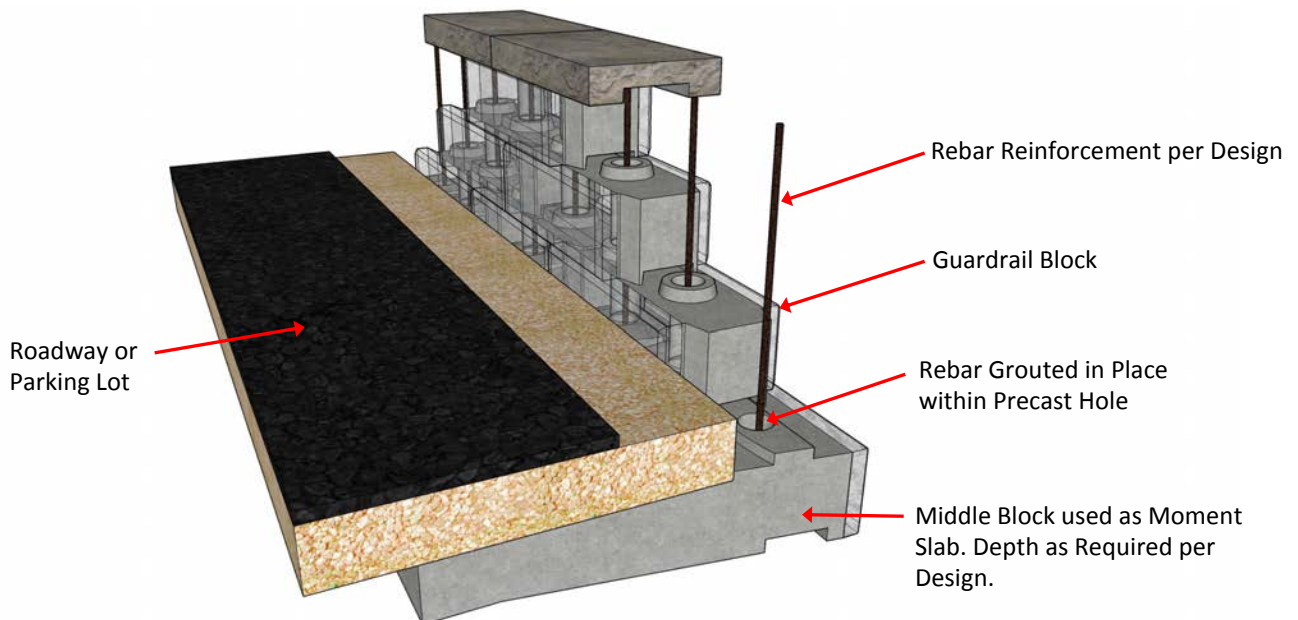

Column Blocks

The final block type in ReCon's lineup is the Column block. Like the Fence block, the Column block is an above grade option that is textured on all exposed faces but is used to create free-standing columns. All the Column block types can be found in the Block Catalog and various installation options are discussed later in this manual.

Since the dimensions of the Column block are similar to that of the Fence block, the analysis completed regarding maximum height is applicable for Column block as well, provided the loading is the same. Adding reinforcement to the Column block core and adding a larger below grade footing would allow for additional height. Final determination of the maximum height should be completed based upon site conditions and anticipated loads.

Finally, it is important that the foundation soils beneath the ReCon Column block be properly prepared during construction and that they are adequate to support the loading from the column.

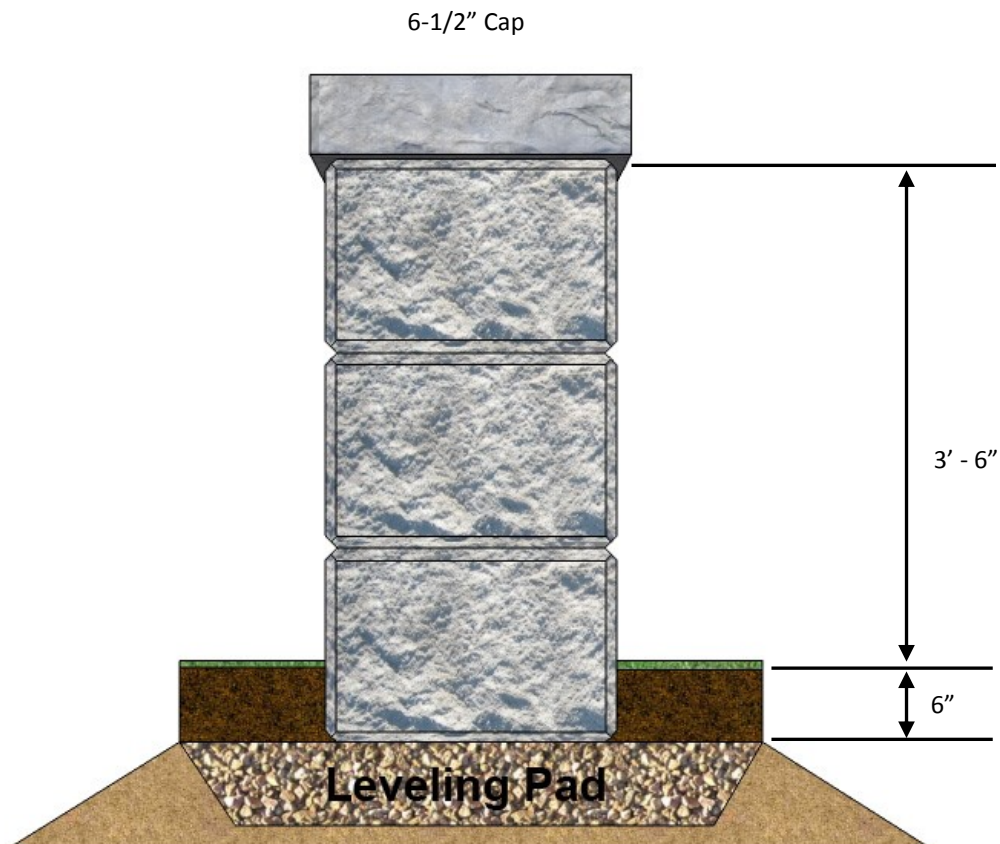

Notes

A large grid of graph paper for taking notes, consisting of 20 columns and 30 rows of small squares.

Construction

Retaining Walls

The following procedures comply with generally accepted industry standards for the installation of Precast Modular Block Retaining Walls with special attention given to the unique features of the ReCon product line. Every attempt should be made to follow these procedures unless the project specifications, drawings or the final engineered wall design directs otherwise. **Additional guidance, which should be reviewed by the contractor, is provided in the ReCon Installation Guidelines and Typical Construction Detail Drawings available at www.reconwalls.com.**

Documenting the Scope of Work

Although unrelated to the actual installation of the retaining wall, proper preparation of a quote or bid can mean the difference between a profitable project, or working hard to merely break-even. Clearly defining your scope of work during the bidding process can remove ambiguity, allow the customer to better evaluate the bid, and potentially mitigate contractor risk. To request a copy of a typical retaining wall project Scope of Work Checklist, please contact ReCon.

Preconstruction Meeting

For a project to run smoothly, it is important that all parties involved fully understand their role in the installation process. Getting the numerous sub-contractors on site to have a common understanding of the timing, coordination, sequencing, and access requirements of each trade is critical. Preconstruction meetings are a good, and often necessary, way to bring everyone together to discuss project roles and coordinate specific site activities.

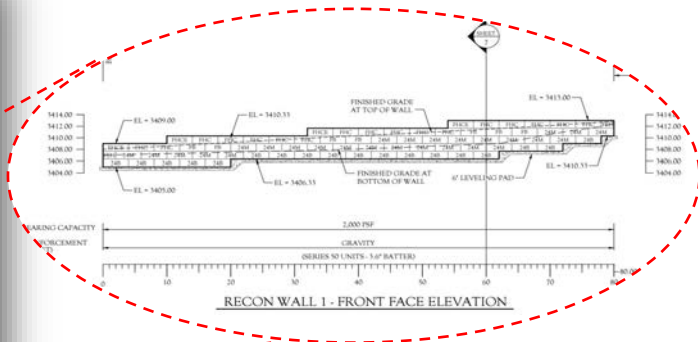

Engineered Shop Drawings

For an installation contractor, having engineered shop drawings (aka: stamped plans or construction drawings) for the retaining wall, prepared by a qualified retaining wall design engineer, is an essential tool that is necessary for the proper installation of a ReCon wall. A variety of information can be obtained from the stamped plan which will guide the installer during the construction process. This information includes items such as: the proper elevation of the wall, the depth of the gravity wall blocks, the length and strength of the geogrids (if applicable), the required bearing capacity of the foundation soils, as well as the location of any curves, corners, or any structure the wall may encounter. Shop drawings can also be used to help coordinate block delivery schedules and set productivity goals for the installation crew.

Site Preparation

Before beginning work, contractors should make sure they have thoroughly studied the project specifications, the engineered shop drawings for the wall and complied with all the requirements for product submittals. Contractors should also have a clear understanding of their scope of work and their responsibilities that may be covered elsewhere in the project specifications and are not in the actual wall construction section.



For projects that do not have a formal set of grading plans or specifications, but do have engineered shop drawings, the contractor should refer to the construction procedures outlined in this manual whenever a topic is not specifically covered.

Make sure to have the retaining wall site properly surveyed and staked by a qualified surveyor. These grade stakes, and elevation hubs, will be the guide for the excavation contractor and will help the retaining wall installer determine the location of the wall. Be sure to have proper stake off-sets to avoid damaging the stakes during the installation process.

Excavation

The contractor should carefully excavate the wall construction area to the lines and grades shown on the construction drawings. Exercise caution to keep the soil undisturbed in areas that will not need modification during wall construction. Be sure to mark the location of any below ground utilities including power lines, communication lines, sewer and drainage structures, etc.



Preparing the Leveling Pad

Using the grade stakes and elevation hubs, excavate the base course trench to a minimum depth of 6-inches and to a width that extends a minimum of 6-inches in front and behind the actual location of the base blocks along their designated placement. It is suggested that a laser transit be used to establish bottom of wall elevation. If the wall layout requires either inside or outside radius curves, it is recommended to increase the width of the leveling pad to accommodate adjustment during wall alignment. Grade stakes should also show where base step-ups are located. It is important to keep in mind that each step-up causes the leveling pad location to step back by one inch due to the integral setback of the ReCon block.



Be sure to examine and test any foundation soil that appears inadequate and may not meet the bearing requirements set forth in the engineered plans.

Fill the trench and any over-excavated areas with the specified base material. Unless noted otherwise, this material should generally consist of a well-draining material that also contains enough fines that the leveling pad will hold its shape after compaction. Depending on the region, this material may be referred to as road base, $\frac{3}{4}$ -inch minus, crush-and-run, or Class 5. Fully compact the base material and add or remove material as necessary to keep the leveling pad as close to the final level grade as possible. Where step-ups are located, base material should taper up at roughly a 45-degree angle.

A concrete leveling pad may be required or desirable in lieu of a compacted granular base material. Unless the leveling pad is designed as a true strip footing that extends below frost depth, the concrete should not contain reinforcing and should consist of a relatively weak mix capable of breaking under frost pressure. This type of footing allows for resettlement as the frost dissipates. Concrete leveling pads, however, do not allow for minor adjustments to elevation or pitch once the concrete cures so it is important to take extra care to keep the pad level and any step-ups at their proper height to avoid difficulty in maintaining height tolerances.

Depending on the type of material used for the leveling pad, and how level the pad is to start with, base course leveling may be easier if the leveling pad is topped with up to $\frac{1}{2}$ -inch of clean sand or loose base course material. This increases the ability of the installer to make adjustments to block elevation, maintain a positive wall batter and minimize rotation during soil compaction when large compaction equipment is used.

Base Course Installation

The first (base) course of a ReCon wall requires the use of a **Base Block**. This block does not have a groove along the bottom, which makes for easier leveling and provides greater frictional resistance at the interface between the leveling pad and ReCon base block.



Walls should generally be built starting at the lowest elevation along the wall. However, if there are corners and/or abutting structures along the wall profile, these locations may be better places to start construction.

As base blocks are laid, ensure that they are in full contact with the leveling pad and check to confirm that the blocks are level both front-to-back and left-to-right. Lay blocks end-to-end and avoid gaps between blocks. The use of a string line will help ensure proper wall alignment along straight sections of wall. Curved base course locations can be established by using the grade stakes and a can of spray paint around the wall radius point.

Extra care should be considered for base course step-ups. Be sure to account for the 1-inch setback when establishing the next course location. If using granular material, the wedge of leveling pad material below the overlapping block must be properly compacted using a hand tamper or vibrating plate compactor. Concrete step-ups should be checked for consistent elevation from one course to the next.

After the base blocks have been placed and before compacting the backfill material behind the wall, compaction to the specified embedment depth should be done in front of the wall.

Backfilling and Compaction

When all the blocks comprising a section of wall at a single elevation have been placed, aligned and leveled, fill the pie-shaped voids between the blocks with a clean crushed rock material at least ½-inch to ¾-inch in size. Use this same material behind the back of the block to a depth of at least 1-foot or as otherwise indicated in the final engineering drawings. Because this material is generally self-compacting, this rock zone reduces the need for installers to operate compaction equipment close to the back of the blocks. In addition, this material can serve as a drainage column behind the block.

At times, a **filter fabric** may be specified behind the drainage aggregate material. This helps keep the drainage zone clean and free from sedimentation. If present, wrap the fabric forward over the drainage aggregate as the other backfill material is placed.



When **drain tile** is used, it should be located as shown in the plans or drawings. Generally, the drain tile runs along the back of the wall and is located near the bottom of the drainage aggregate zone. Drain tile should be installed at an elevation at or slightly above the finished grade level at the front of the wall, unless otherwise specified. Drain tile should daylight through the face of the wall at least every 50-feet along the length as well as at every low point in the wall, unless otherwise specified.

Place the specified backfill material and thoroughly compact the material in 8-inch lifts. Backfill material should be compacted to minimum 95% of standard proctor density. **Improper or inadequate compaction is a primary source of contractor-caused wall settlement and failures.** Close attention should be paid to changes in consistency and moisture content of all backfill material. Depending on the backfill type, it is important to use the proper type of compaction equipment. For sandy or gravelly materials, it is typical to use plate compaction equipment. Clayey materials generally require kneading by using a hand-operated jumping jack or sheep's foot roller. Only hand-operated compaction equipment shall be used within 3-feet of the back of the ReCon blocks. Large, heavy compaction equipment should be kept a minimum of 5-feet from the back of the ReCon blocks to avoid wall rotation.

Placing Additional Courses

Prior to placing successive courses, remove and keep clean any backfill material from the top of the ReCon blocks and make sure that all voids are filled with the proper drainage material. A hand-operated or backpack leaf blower makes quick work of this task. Place the next course in a running bond pattern or as otherwise shown on the engineer's detailed wall elevation. Set the upper block and **slide it forward to engage the groove with the tongue on the block below.** Check and adjust level at every course elevation.

If shimming is required, plastic shims with high compressive strength should be used. Cover as much of the low surface area as possible to achieve the desired result and to minimize any point loading.



Geogrid Placement

When a geosynthetic reinforcement (geogrid) is required, use only the type/s specified. Also, make sure the reinforcement is cut to the proper lengths as indicated on the final engineered plan. Most geogrid types are uni-axial (stronger in one direction) and ***must be laid with the manufacturer's edge perpendicular to the wall face.***

Check the manufacturer's data to insure proper orientation. The geogrid should be laid on the top of the block as near to the front face as possible and extend back over a compacted, level backfill to the length required. Sandwich the reinforcement under the next course of ReCon blocks to anchor in place. Pull the tail (loose end) of the grid taut to remove slack or wrinkles. Stake the tail of the geogrid prior to placing backfill material to maintain tension. When placing backfill over a layer of geogrid, start just behind the drainage aggregate and fill toward the tail of the geogrid. Avoid operating backfill equipment directly on the tensioned geogrid as much as possible. A minimum of 6-inches of backfill should be placed over the grid before driving any equipment on top of the grids. Avoid sharp turning and sudden braking with all types of equipment to avoid displacing, wrinkling or damaging the geogrid reinforcement.

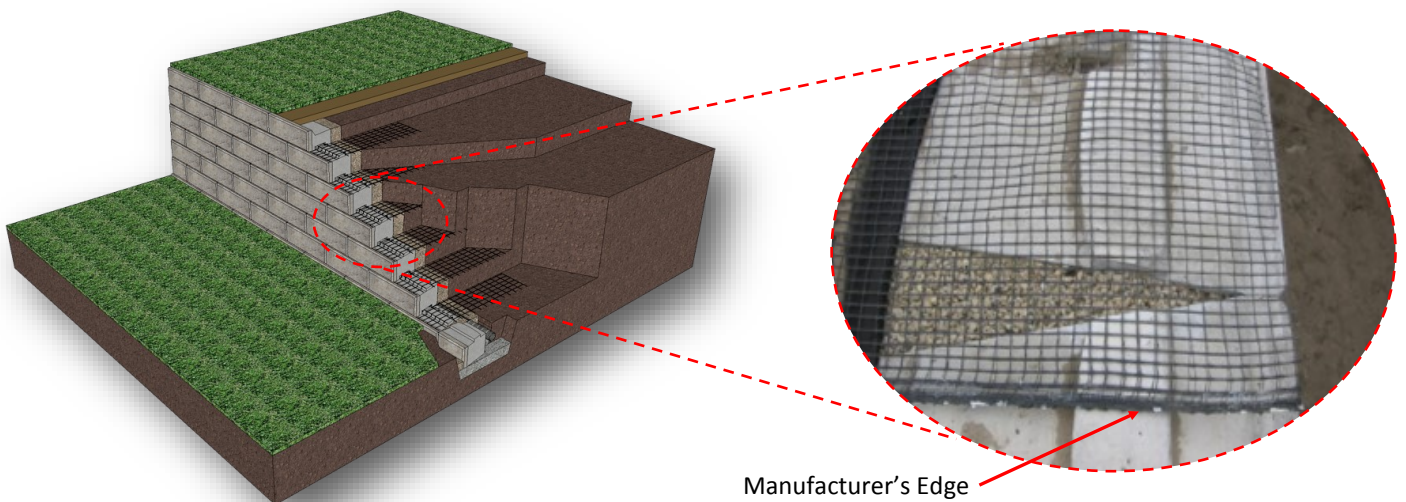

Curved Walls

The absolute minimum turning radius for ReCon blocks is a little over 13-feet. Due to the integral setback of the blocks, the actual minimum radius grows or shrinks by approximately 2-inches for each additional course depending on whether it is an inside or outside curve. For ease of installation, it is recommended that the radius, of a multiple course wall, be no less than about 15-feet at the bottom of an inside radius or top of an outside radius wall. From this starting point, you should add approximately 2-inches for each additional course on a curved wall.

Because ReCon blocks have a fixed length and a built-in setback, walls constructed along radiuses will tend to run off-bond over long curves and as the height of the wall increases. For wall integrity, it is recommended that whenever a point is reached where there is less than 1/3 of an upper block bearing on the block below, a partial block (created by cutting a fitting block) should be inserted into the wall to return the bond to normal. For aesthetic purposes, it is recommended that you stagger any partial blocks placed so they don't all occur in the same section along the length of the wall face.

Inside Curve Minimum Radius		
Wall Height (ft)	Number of Courses	Top Row Min. Radius (ft)
2.67	2	15.17
4.00	3	15.33
5.33	4	15.50
6.67	5	15.67
8.00	6	15.83
9.33	7	16.00
10.67	8	16.17
12.00	9	16.33

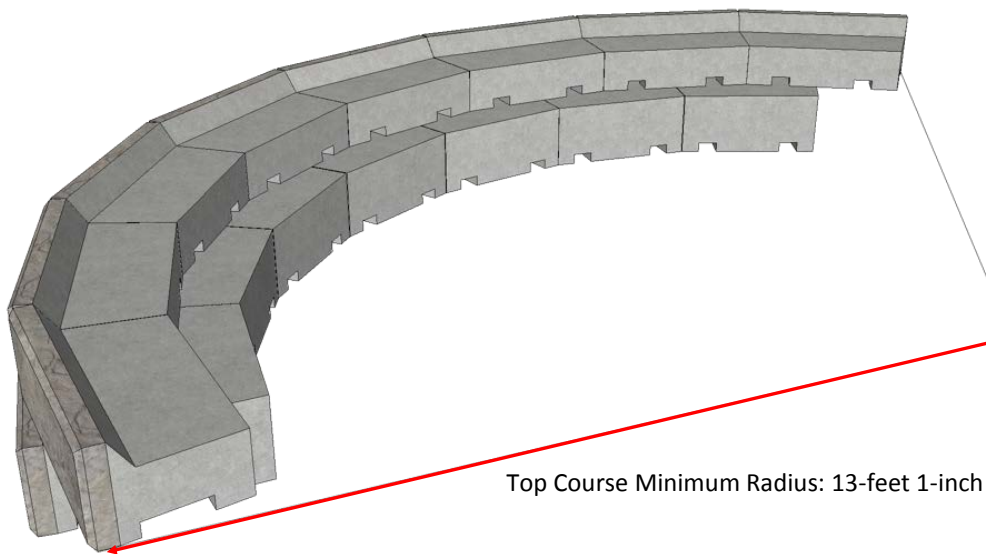
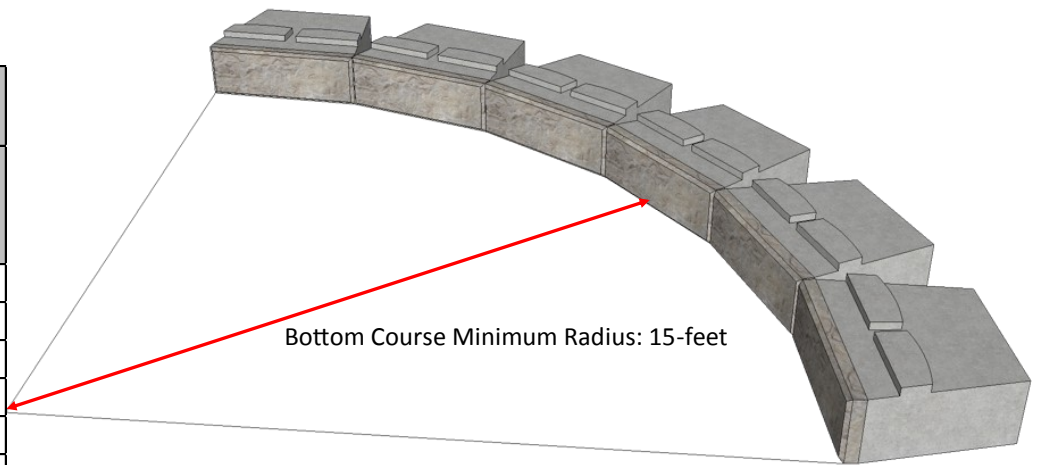

Outside Curve Minimum Radius		
Wall Height (ft)	Number of Courses	Top Row Min. Radius (ft)
2.67	2	14.0
4.00	3	14.5
5.33	4	15.0
6.67	5	15.5
8.00	6	16.0
9.33	7	16.5
10.67	8	17.0
12.00	9	17.5

Geogrid Placement on Curved Walls

Most accepted design methodologies stipulate that the reinforcement shall be continuous along the length of the wall at both the front and rear of the reinforced soil zone. Geogrid layers should not overlap unless there is at least 3-inches of compacted soil separating the individual layers. In addition, the natural rectangular sections of geogrid should *never* be cut to form a wedge shape.

Rectangular reinforcement sections will naturally overlap in a pie-shaped fashion at either the front or the back of the reinforced zone depending on whether it is an inside or outside curve. The figures show how reinforcement is laid out in this situation. All the pie-shaped overlap areas should be separated by at least 3-inches of backfill.

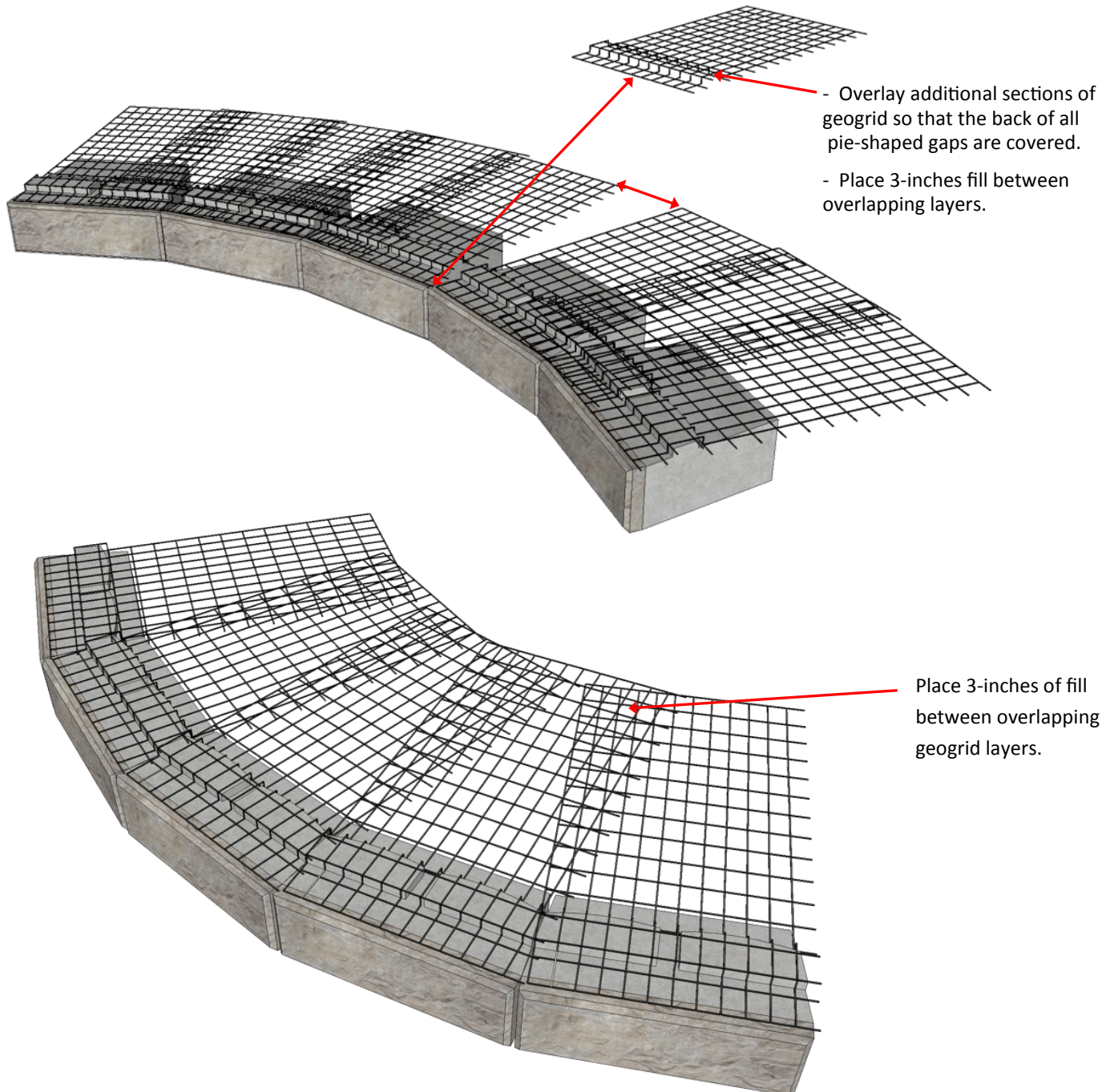

Outside 90-degree Corners

When building a wall with an outside 90-degree corner, it is recommended that construction start at the corner and work away from this point in both directions. Unless one of the walls going away from the 90-degree corner runs into another corner or abutment, no block should need to be cut. One standard corner block will be used at the corner on each course, alternating the long and short returns. The corner blocks should be glued at the corner where they overlap with a high-quality, exterior-grade concrete adhesive and extra drainage stone placed in the corner (Refer to ReCon Typical Construction Drawings for additional information).

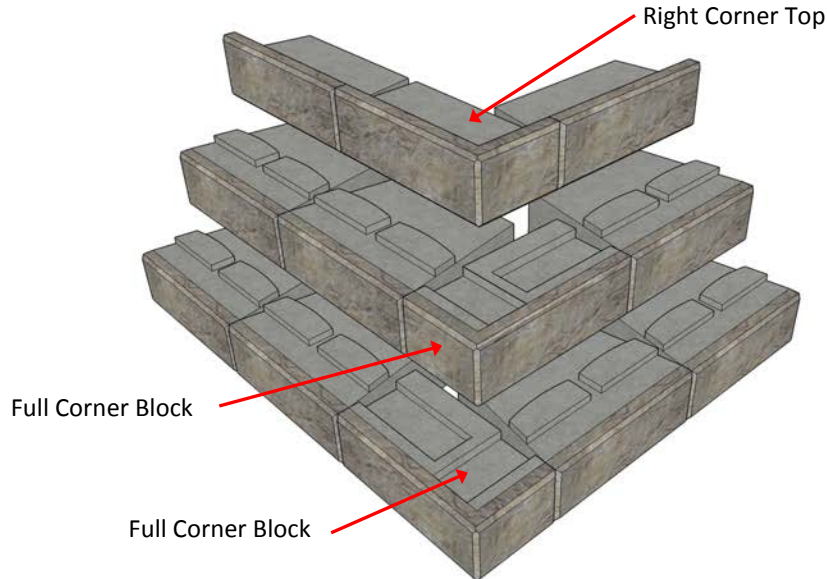

Inside 90-degree Corners

When building a wall with an inside 90-degree corner, it is recommended that once the base row is laid to the location of the inside corner, subsequent courses should begin at the corner and be laid outward from there. This aids with the alignment of blocks at the corner, given the 1-inch setback that will occur with each additional course of block. On taller walls, the running bond joint will tend to slide off center by 2-inches for every other course of block placed but this does not affect the integrity of the wall. In the corner, a portion of the tongue on one block will need to be removed as shown below. It is preferable to use a retaining wall block with a portion of the tongue removed in lieu of a corner block (especially for taller gravity walls). The use of the retaining wall block in the corner provides full engineered depth of the block at the corner. If a corner block is used, then the blocks must be glued where they overlap.

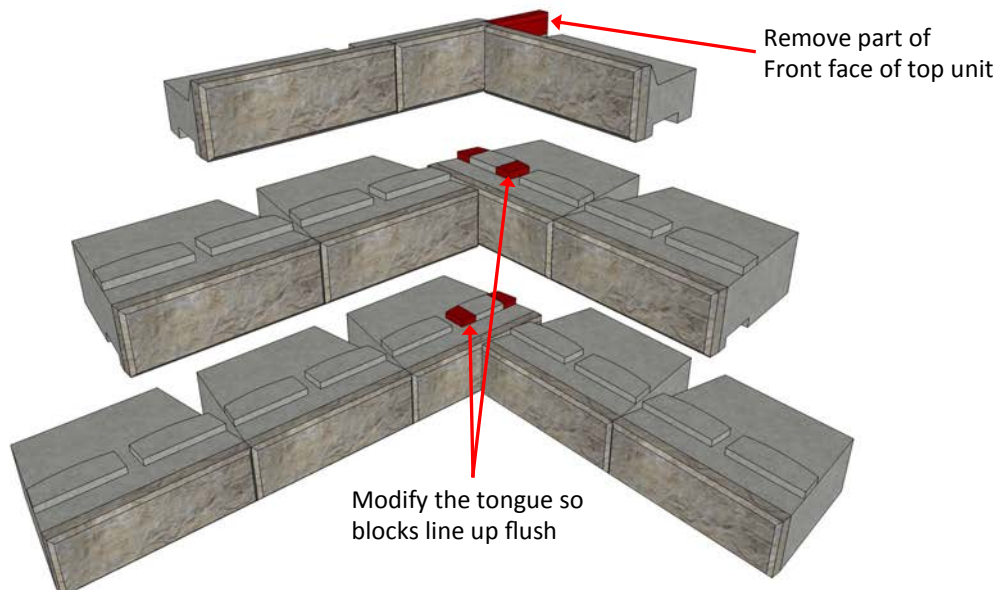

Double Outside 90-degree Corners

When building a wall with a section that is terminated on each end with an outside 90-degree corner, start by placing the corners in their proper location and elevation. Because the wall will narrow by 2-inches (on a 3.6-degree battered wall) for each successive course, a partial block must be cut to fit somewhere along the length of the wall. Use a ReCon fitting block to create this partial block, thus making the cutting procedure easier. For aesthetic purposes, it is recommended that you locate these partial blocks at varying locations along the length of the wall.

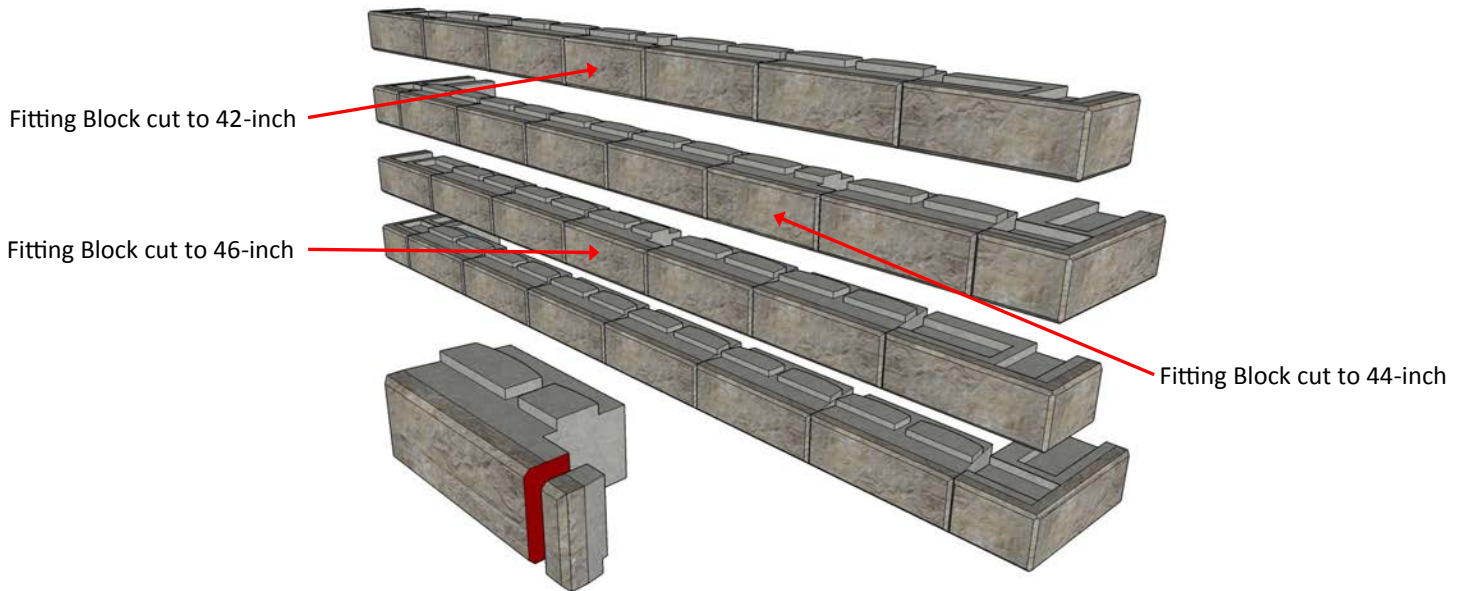

Outside 90-degree Corner to Abutment

At times, a ReCon wall may start against an abutment, such as a garage or walk-out basement. Often the other end of the wall will turn with a 90-degree corner. When such a wall is built with the normal setback, each successive course will be 1-inch shorter in length than the course below. The simplest way to build this wall is to use the ReCon fitting block and cut the fitting end so that the block will fit into the space left after the rest of the blocks on that course have been laid.

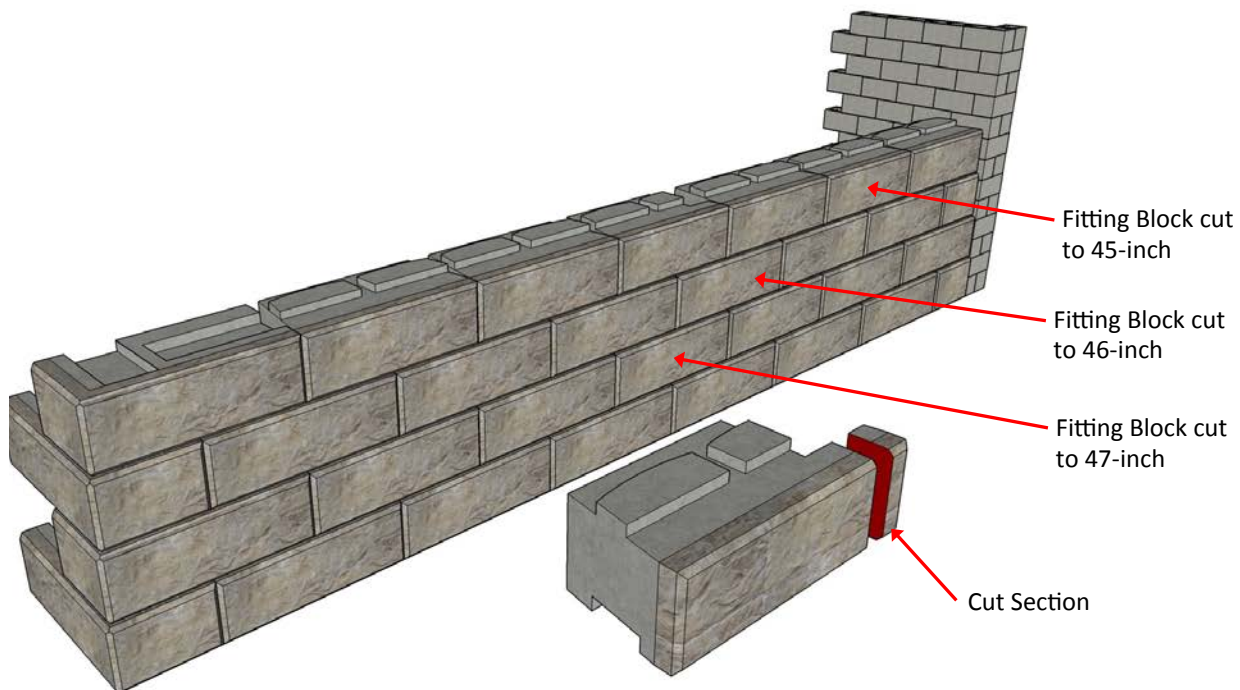

Top of Wall Treatments

There are several options when finishing the top of a ReCon retaining wall including the use of top blocks, caps, and full-high caps. Other treatments are available and typically involve special construction, such as forming and pouring a concrete parapet or attaching specialty, precast components.

ReCon Top Blocks

Using the ReCon top blocks to finish off a wall allows for the ability to fill blocks with a landscape rock or plant material to within 4-inches of the wall face. When stepping up or down at the top of a wall using top blocks, a corner top block is used to make this transition. A corner top block can be laid with either the 2-foot or 4-foot face as the return side. Usually the wall layout elevation plan, prepared by the design engineer, will indicate the proper block location or type. In the absence of such a plan, the left and right corner top blocks designate which side the 2-foot return dimension is located as you face the finished wall. This is referred to as **standard placement**.

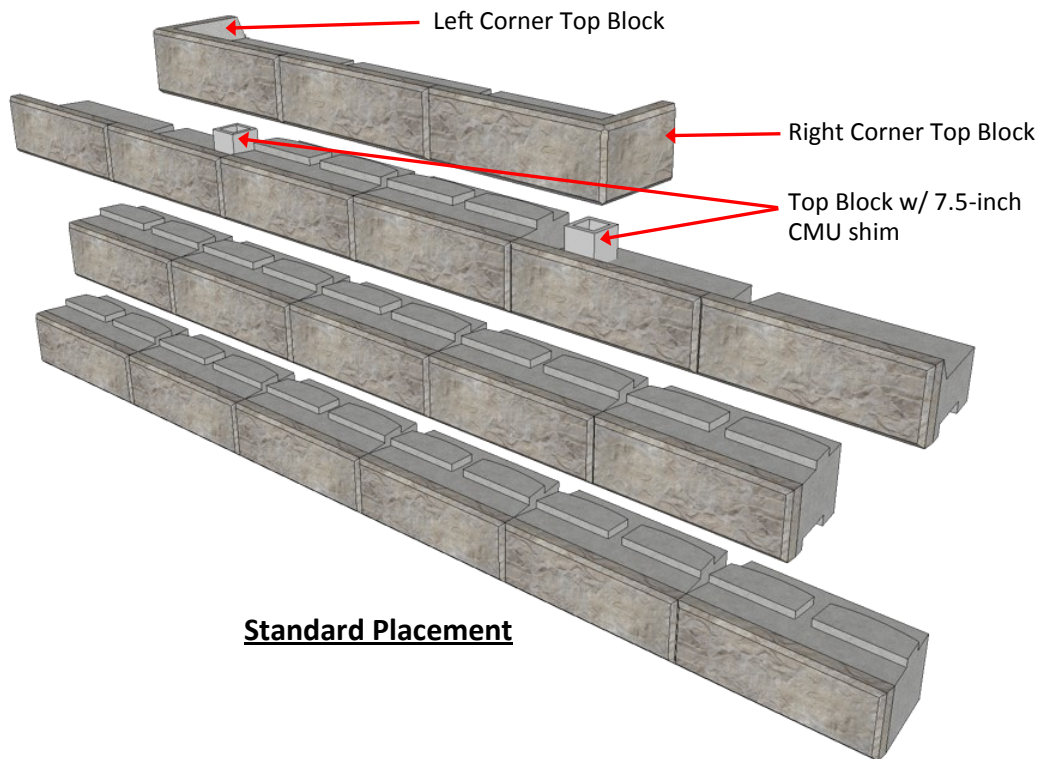

When the standard placement (4-foot face, 2-foot return) is used, it will be necessary for block stability to add a concrete shim beneath the portion of the corner top block that bears over the top block below. This shim is usually made or cut, if necessary, from a standard concrete masonry block (CMU). Gluing this shim in place will resist movement during the backfilling process.

If it is desired that the 4-foot face returns into the retained soil, then a left corner top block will return (with respect to the wall face) on its right side and visa-versa for a right corner top block. This is referred to as **alternate placement** as shown in the figure on the next page.

When alternate placement is used, it will not be necessary to shim beneath the corner top blocks. In this scenario, the block will be resting entirely on half of a full block below. For the corner top block to lay flat and level, approximately 7-inches of the tongue on the lower block must be removed as shown in the figure.

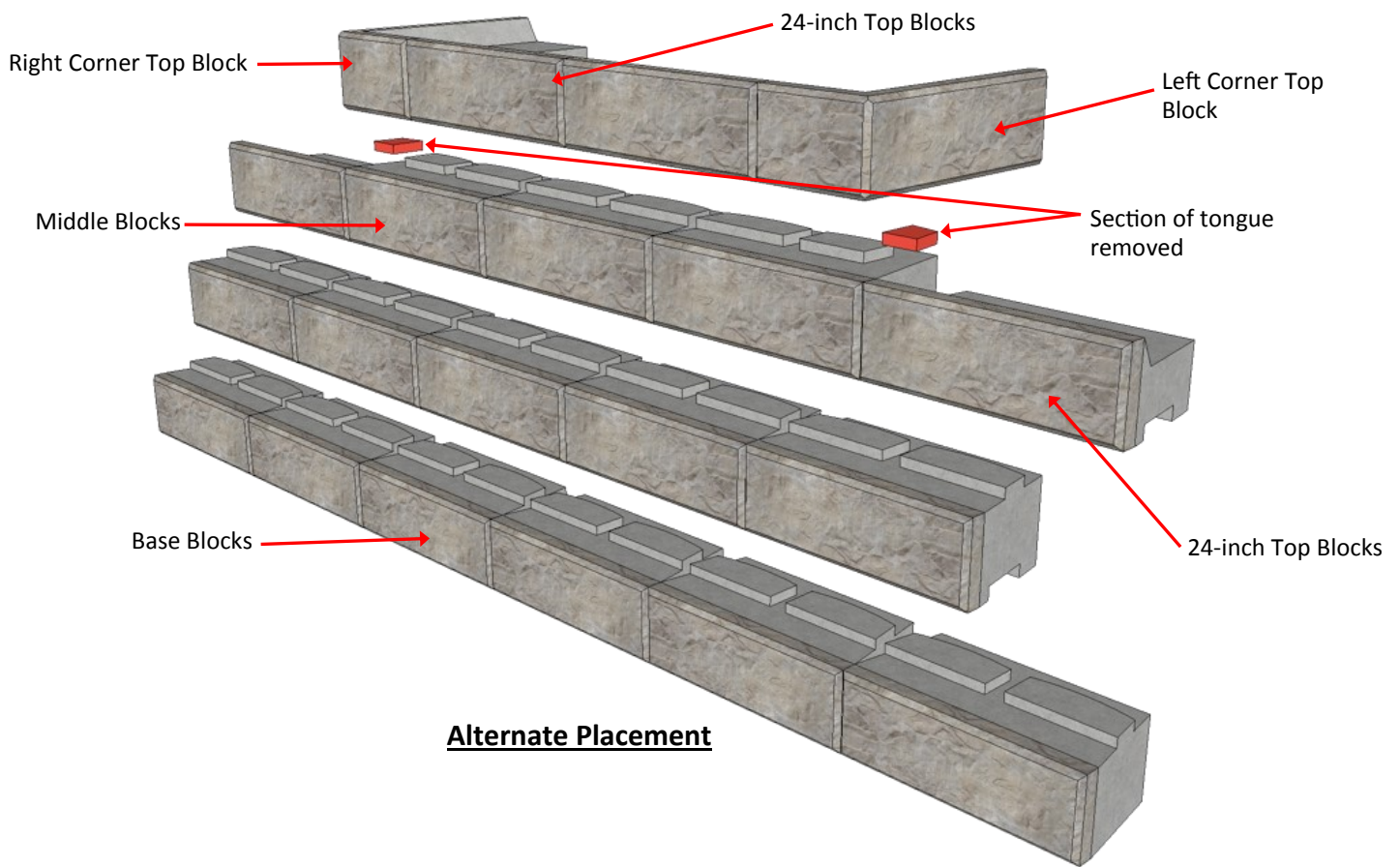

Cap Blocks

ReCon Cap Blocks are rectangular and are available in two types, a regular cap that has a groove along the entire bottom of the block and an end cap where the groove terminates 4-inches short of the end to provide a finished end appearance. These caps are placed with a scissor clamp and are intended primarily for straight walls. If cap blocks are to be used atop curved wall sections they will need to be cut to provide a continuous finished appearance. Additional installation time must be considered when cutting cap blocks around a radius.

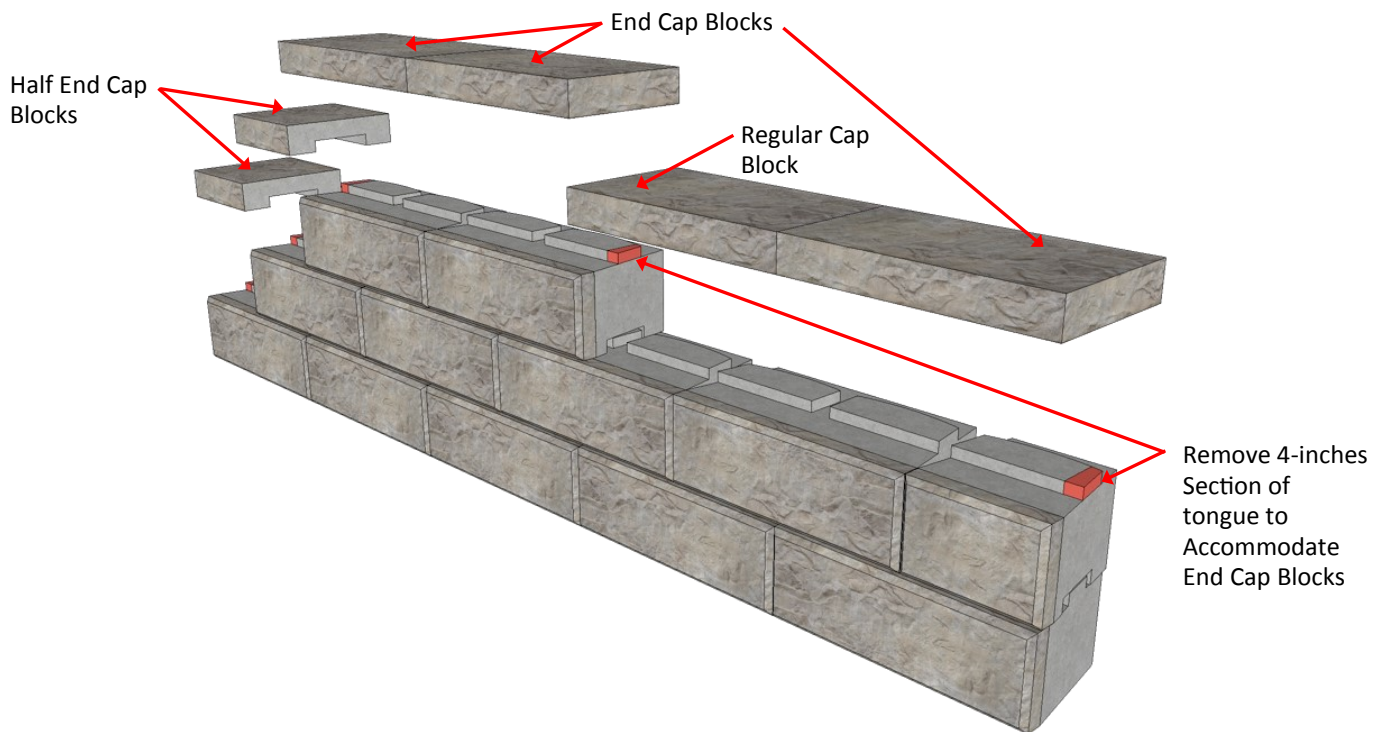

Full-High Cap Blocks

ReCon Full-High Cap Blocks can be used when freeboard, above the top of wall finished grade, is required. This solution can be useful when the wall involves numerous step-ups at the top of the finished wall and a finished appearance is desired for all exposed block above grade.

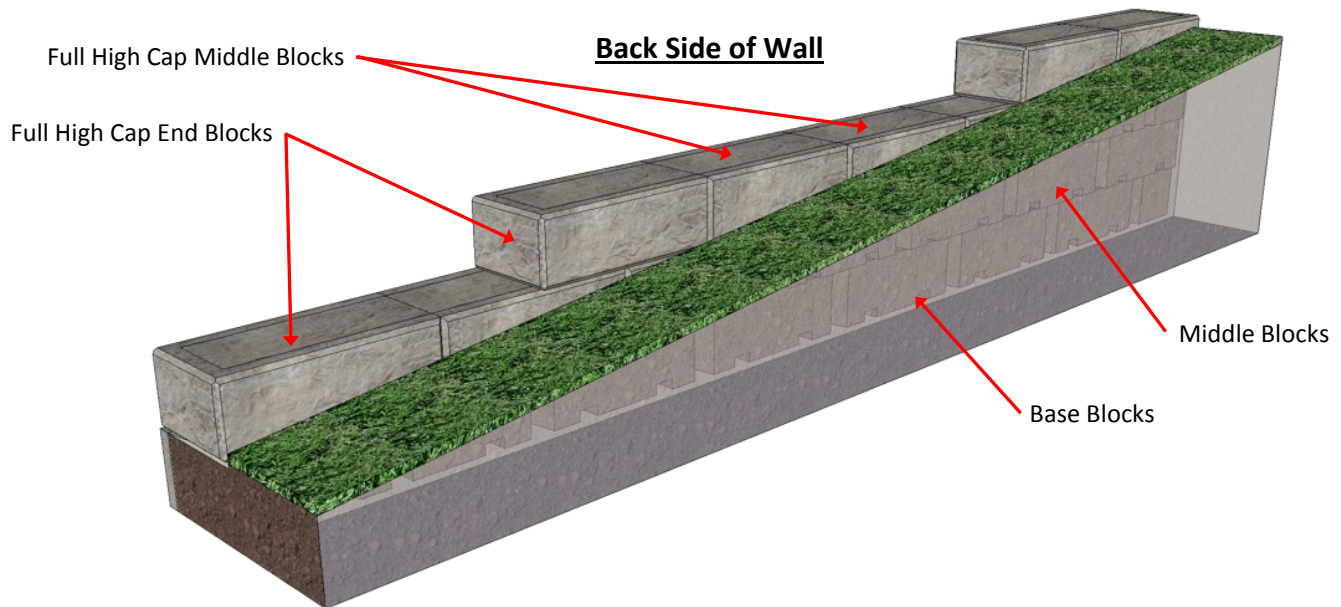

The top of a ReCon retaining wall or free-standing wall can be finished using the ReCon Full High Cap (16-inches high). When the wall is curved, miter cutting will be required to eliminate the opening that will form between the blocks. Cutting the ReCon Full High Cap can require substantial effort since it is a solid piece of concrete, 24-inches thick and 16-inches in height. To reduce the time and energy required to complete this cut, ReCon offers a Full High Cap Middle FITTING Block. This block is precast with a recess on one end of the block that is 6-inches deep and leaves about 4-inches of concrete along the top and sides of the block. Thus, the time required to cut this thinner section is significantly reduced when using a standard 14-inch concrete chop saw.

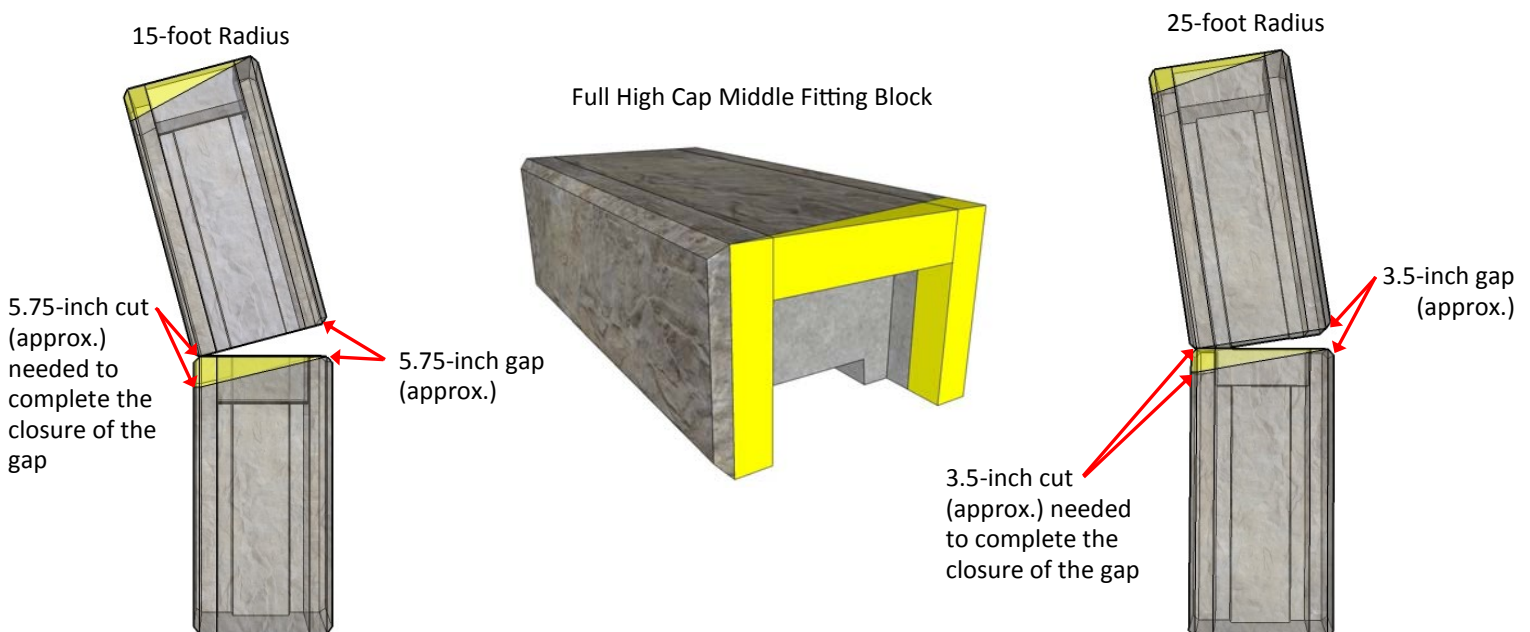

Steps

There are numerous configurations that incorporate steps into a retaining wall. The most common is where the steps begin at the base of the wall and go up through the wall to the top grade. It is important to note that when stacking steps on top of each other, the actual change in elevation from the top of the first step to the top of the second step, and so on, can be more than the 6.5-inch height of a step due to the slightly uneven texture on the top of the step, the thickness of the glue used between the steps, and some tolerance variation in the production process. If the actual finished elevation of a step or a landing within the steps is critical, it is recommended that the design assume 7-inches of rise per step (not 6.5-inches). See ReCon Drawing #702, Steps, for further clarification.

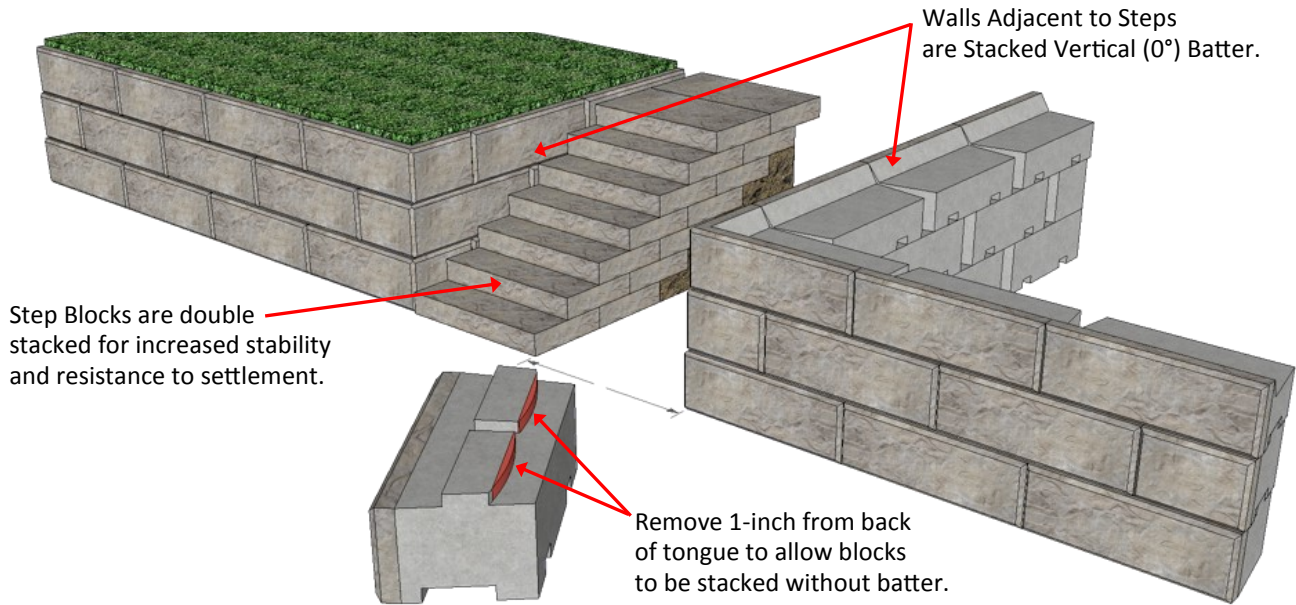

Independent Pedestrian Railings, Fences, and Traffic Barriers

Independent railings, fences, and barriers placed behind a ReCon wall (not attached to or a part of the ReCon blocks) may effect the design of the retaining wall. Please refer to the Design Considerations portion of this manual for additional information regarding design.

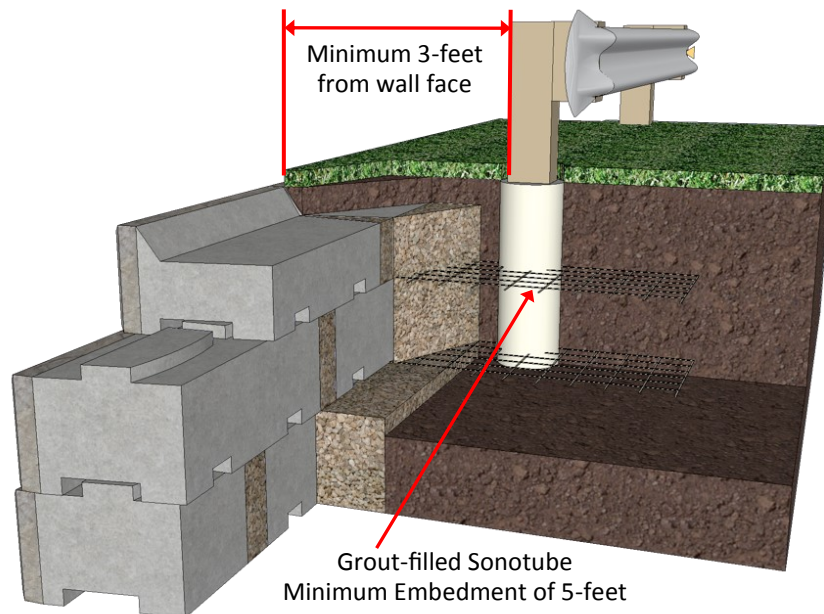

When constructing independent railings, fences, and traffic barriers, it is important that there is coordination between the wall installer and the contractor that will be installing the independent railing system. This will ensure that both are installed in the most efficient manner possible.

In the case of geogrid reinforced walls, installation of the sonotubes for the railing, fence or traffic barrier will be dependant on various site conditions. If the first layer of geogrid is deep enough below grade and/or the diameter of the hole required is small enough, it may be suitable to auger the holes after the wall installation is complete. Otherwise, installation of the sonotubes will need to coincide with the wall and geogrid installation with the grids being cut to fit around the sonotube.

Integral Pedestrian Railings and Fences

ReCon units can be manufactured to accommodate certain types of railings or fences that are attached directly to the ReCon block. See Design Considerations: Integral Pedestrian Handrailings and Fences in this Manual. Again, the railing or fence should be designed by a qualified engineer before wall construction begins since these structures may impact the design and / or the construction of the wall. The retaining wall installer should specify in the scope of work portion of their quote, whether or not they intend to install the railing or fence. See ReCon Drawing #401 and #402 for additional installation information.



Staining and Sealing

The ability to stain a ReCon wall is an attractive benefit to owners and specifiers. When applied by experienced professionals, modern day concrete stains combined with the realistic stone appearance of the ReCon textures, can render a finished ReCon wall nearly indistinguishable from natural stone.

There are a variety of products that can be used to stain a concrete surface. They range from water born concrete stains, acid etch stains, to hybrids products that combine features of both. Water born stains are the easiest to apply and are environmentally friendly. They come in a wide range of colors, from light tans to deep brown, gray, charcoal and even black.

Customers typically want to match the look and color pallet of existing natural stones that have already been incorporated into the site. Thus, it is recommended that the customer provide to the staining contractor a sample of the natural stone that they want to replicate. The contractor can then stain several ReCon blocks that are already incorporated into the wall, showing the customer a range of options intended to meet expectations. Selection can be made on site and the balance of the wall stained accordingly. Most ReCon walls that are stained utilize a multi-color stain approach which has a base coat and several highlight colors. For specification purposes, the number of highlights desired should be disclosed, as each highlight will add slightly to the cost of the staining process. For example, the specification may indicate “a base coat and two highlights”.



Acid etch stains require an additional degree of care and skill to properly apply. Acid etch stains create deep colors (usually dark browns and rusts) and a natural variation in the color which adds to the authenticity of the finished wall appearance. For additional information on acid etch stains and hybrid stains, please contact ReCon.

Please note that the staining of a ReCon wall is an aesthetic option. It is not necessary from a durability perspective.

Sealing is an option where it may be desirable to minimize moisture absorption or add protection against the adverse impact of road salts, although most ReCon walls are not sealed.

Please consult ReCon’s website, www.reconwalls.com, and ReCon’s Specification for more information regarding staining and sealing. Application of all stains and sealers should follow the manufacturer’s recommendations.

Construction Documentation

It is recommended that wall installers create and retain thorough documentation of their work. This may include foundation soil testing, backfill compaction testing, and photos of wall construction; from base of wall to placement of the impermeable soil cap at finished grade. Documenting that the construction of the wall was completed in accordance with the stamped shop drawings and ReCon’s installation instructions and guidelines, is a step that demonstrates a commitment to quality and will differentiate the installer from the competition.

Fence and Guardrail Block Walls

Independent and Integral Free-Standing Walls

The construction of an independent or integral free-standing wall is similar to that of a ReCon retaining wall in terms of foundation preparation and block placement. For further information, refer to the retaining wall construction section of this manual or the Fence Block Specification and Installation Instructions found on our website.

With respect to integral free-standing walls, it is important to maintain retaining wall block levelness from front-to-back as the wall is constructed. This ensures that the first Fence Block course will be installed level as well.

A	Retaining Wall Base
B	Retaining Wall Middle
C	Fence Base Flat End
D	Full High Cap End
E	Fence Middle
F	Fence Middle Flat End
G	Fence Middle End
H	Full High Cap Middle
I	Half Fence Base End
J	6.5-inch End Capstone - Cut
K	6.5-inch End Capstone
L	6.5-inch Capstone

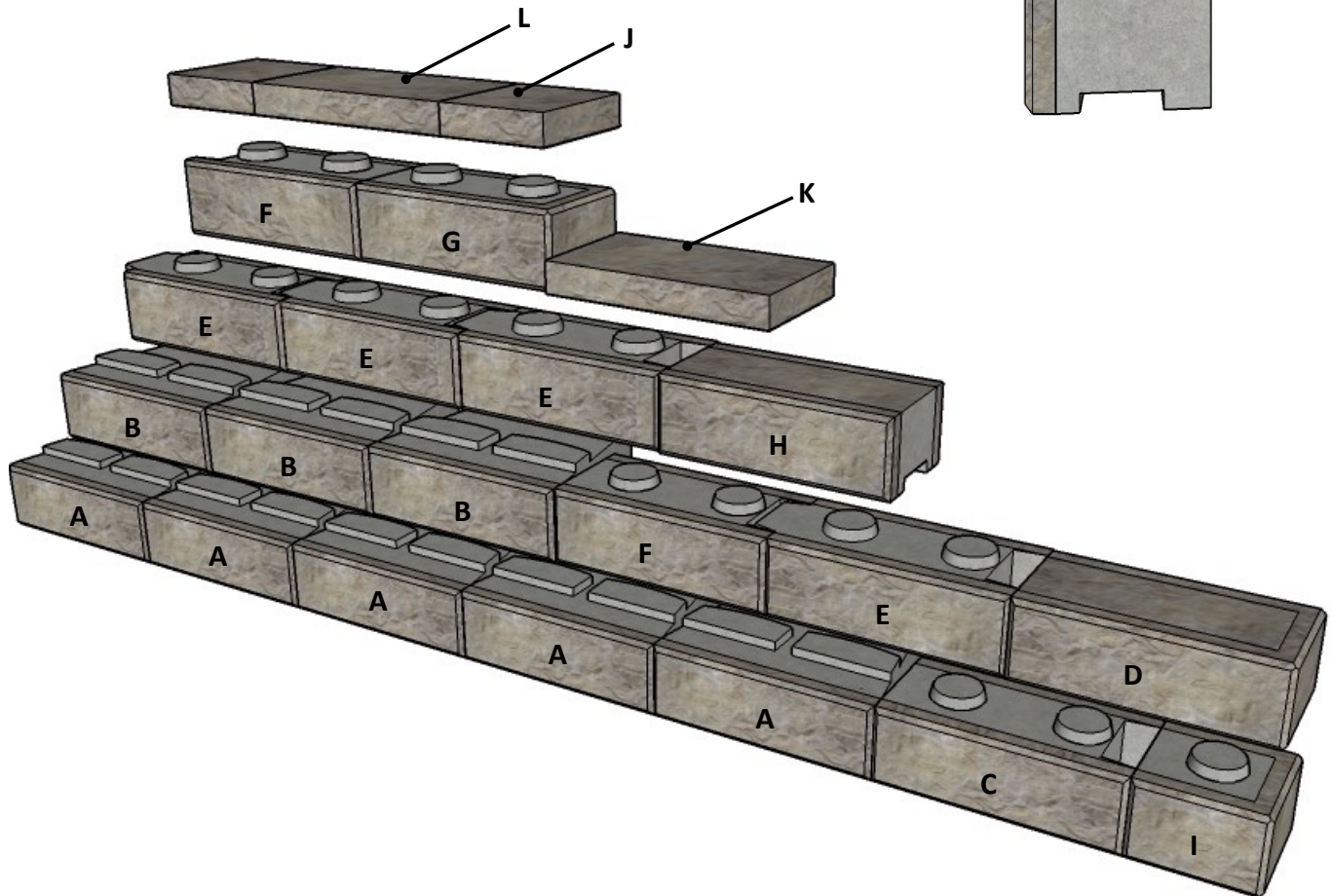
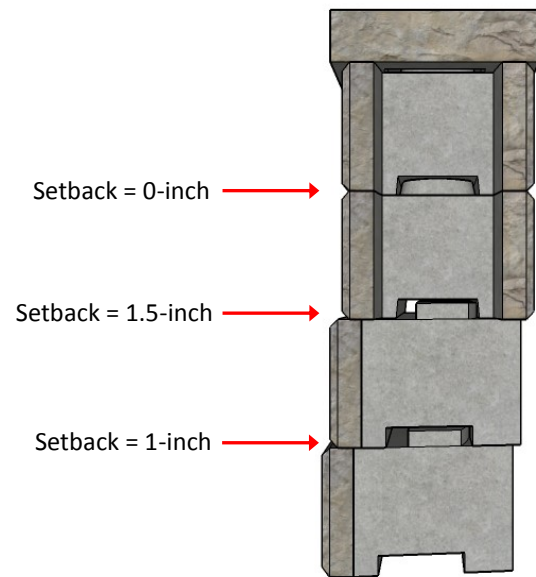

Traffic Barriers

The construction of a traffic barrier utilizing the ReCon Guardrail Block consists of rebar reinforcement placed into grouted cores. It is critical that the cores align vertically and that the rebar and grout are properly sourced and installed. For further information, refer to the retaining wall construction section of this manual or the Guardrail Block Specification and Installation Instructions found on our website.

With respect to integral Guardrail Block walls, it is important to maintain retaining wall block levelness from front-to-back as the wall is constructed. This ensures that the first Guardrail Block course will be installed level as well.

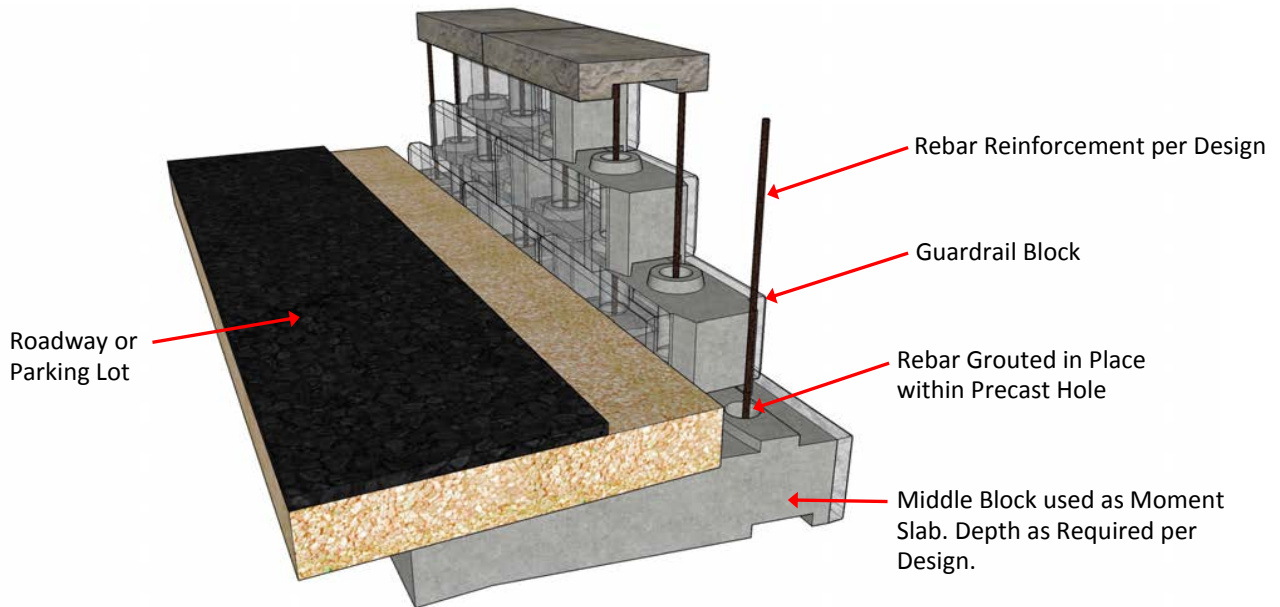

Curved Walls – Fence Block

Introducing a curve into a fence wall, especially when the wall product is 24-inches thick, can create some challenges. The design and configuration of the ReCon Fence Block was intended to balance versatility with ease of construction and great aesthetics. The end-to-end tongue and groove design of the ReCon Fence block allows the contractor to construct curved walls without needing to cut each block along the curve.

Along the outside curve side of the wall, there will be a small opening between adjacent block face textures. The tighter the radius, the greater this opening will become. However, because of the tongue and groove design, the opening will not appear as a visible crack or gap from either side of the wall.

If, however, the customer does not want this small opening, then the installer can simply cut the block “wings” along the inside curve side of the wall to eliminate or reduce the opening on the outside curve of the wall. Cutting the block wings, which is a 4-inch thick section, to close this opening is much easier and quicker than miter cutting through an entire Fence block that is 24-inches thick. In some cases, a small portion of the adjacent block’s tongue will need to be removed as well.

The drawings on the following page show the size of the opening that results when a wall has a 15-foot and a 25-foot radius. These drawings also show the approximate amount of trimming that would be required if it is desired to close the opening.

15-foot Radius

Option 1
Leave Opening

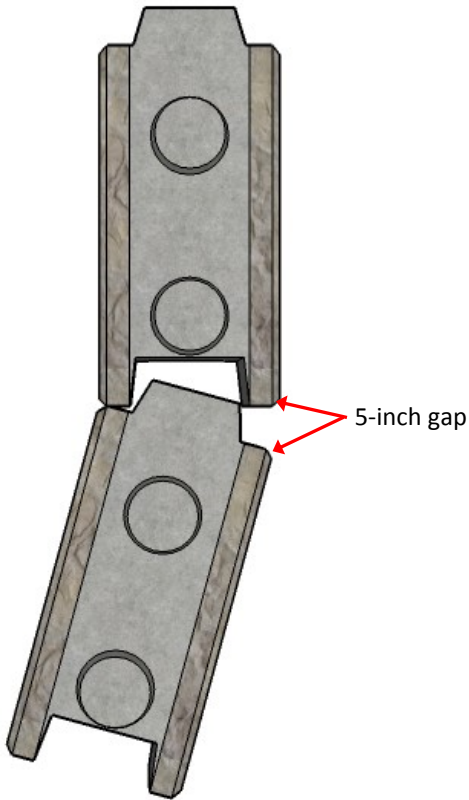

Option 2
Trim Wing & Close Opening

Cut approximately 3-inches off tongue to complete gap closure

Cut approximately 5-inches off wing to close gap on outside curve side of wall

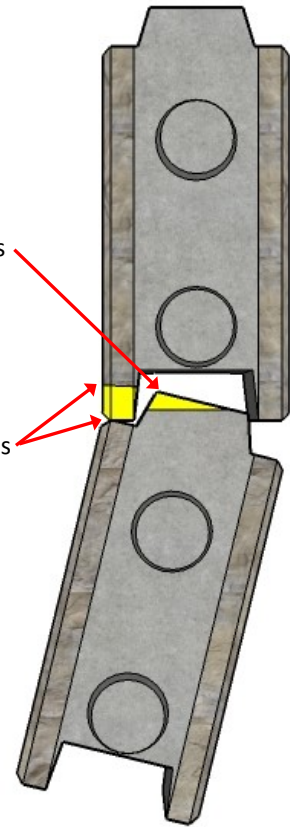

25-foot Radius

Option 1
Leave Opening

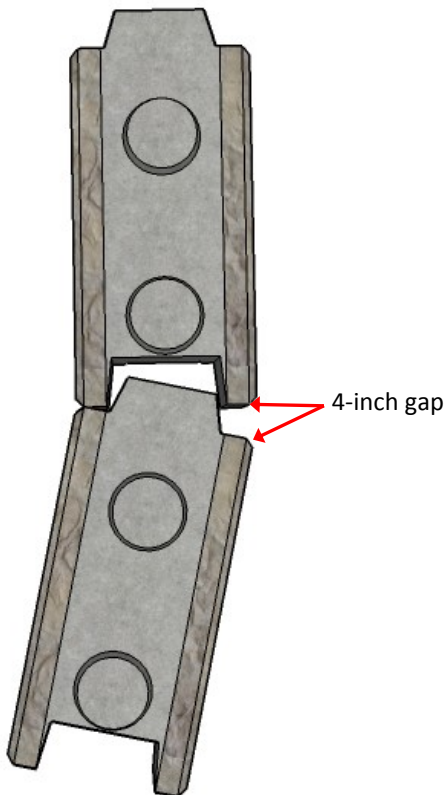

Option 2
Trim Wing & Close Opening

Cut approximately 2-inches off tongue to complete closure of gap

Cut approximately 4-inches off wing to close gap on outside curve side of wall

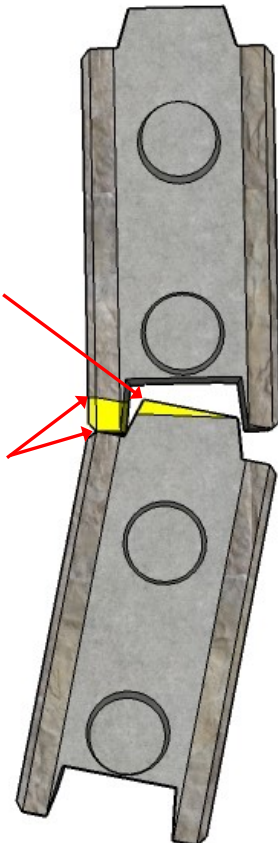

Curved Walls – Guardrail Block

When constructing a traffic barrier along a curved wall, using ReCon’s Guardrail block, block alignment is critical. Each of the Guardrail blocks is precast with two 6-inch diameter holes through the block that are spaced 24-inches apart. These holes must align vertically to allow for proper installation of rebar and grout. As the radius of the curve becomes tighter, alignment of these holes becomes more of a challenge. For this reason, the minimum radius for both inside and outside curves should be limited to 50-feet. If your project requires a traffic barrier along a wall curve, please contact ReCon for additional guidance as some block cutting and/or core drilling may be required. For information on the grout to be used in the reinforcing holes, please consult the Guardrail Block Specifications and Installation Instructions available at www.reconwalls.com.

Minimum Turning Radius, Inside Curve 50-feet

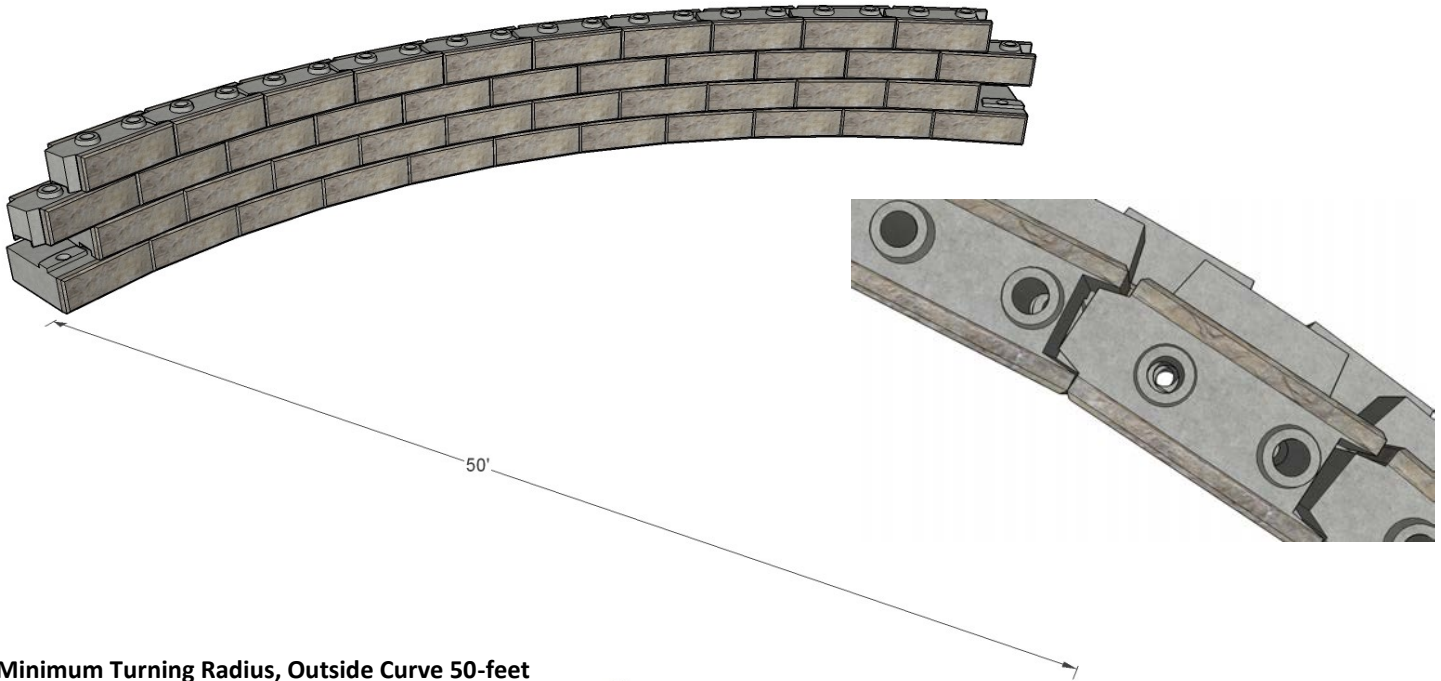

Minimum Turning Radius, Outside Curve 50-feet

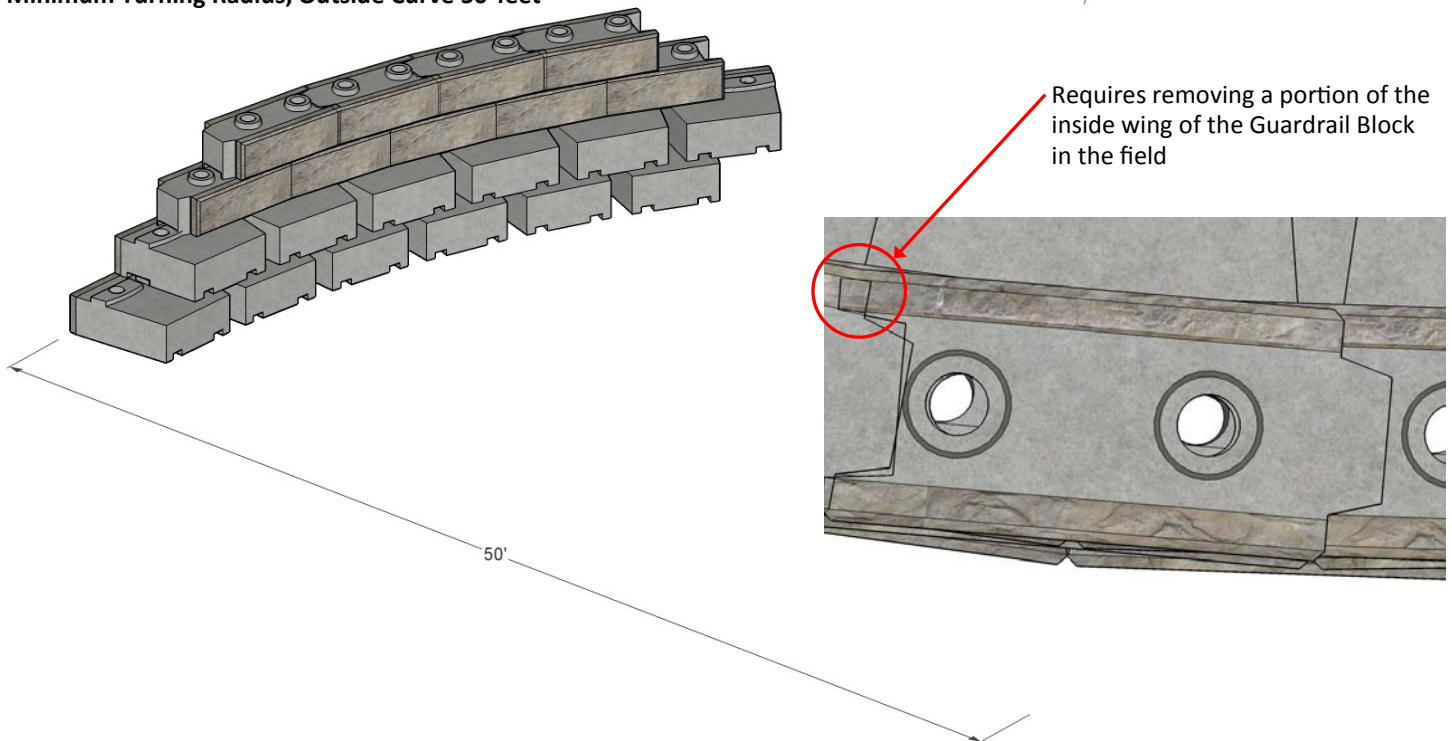

90-degree Corners

The figure below shows the typical construction of a 90-degree corner using ReCon Fence block.

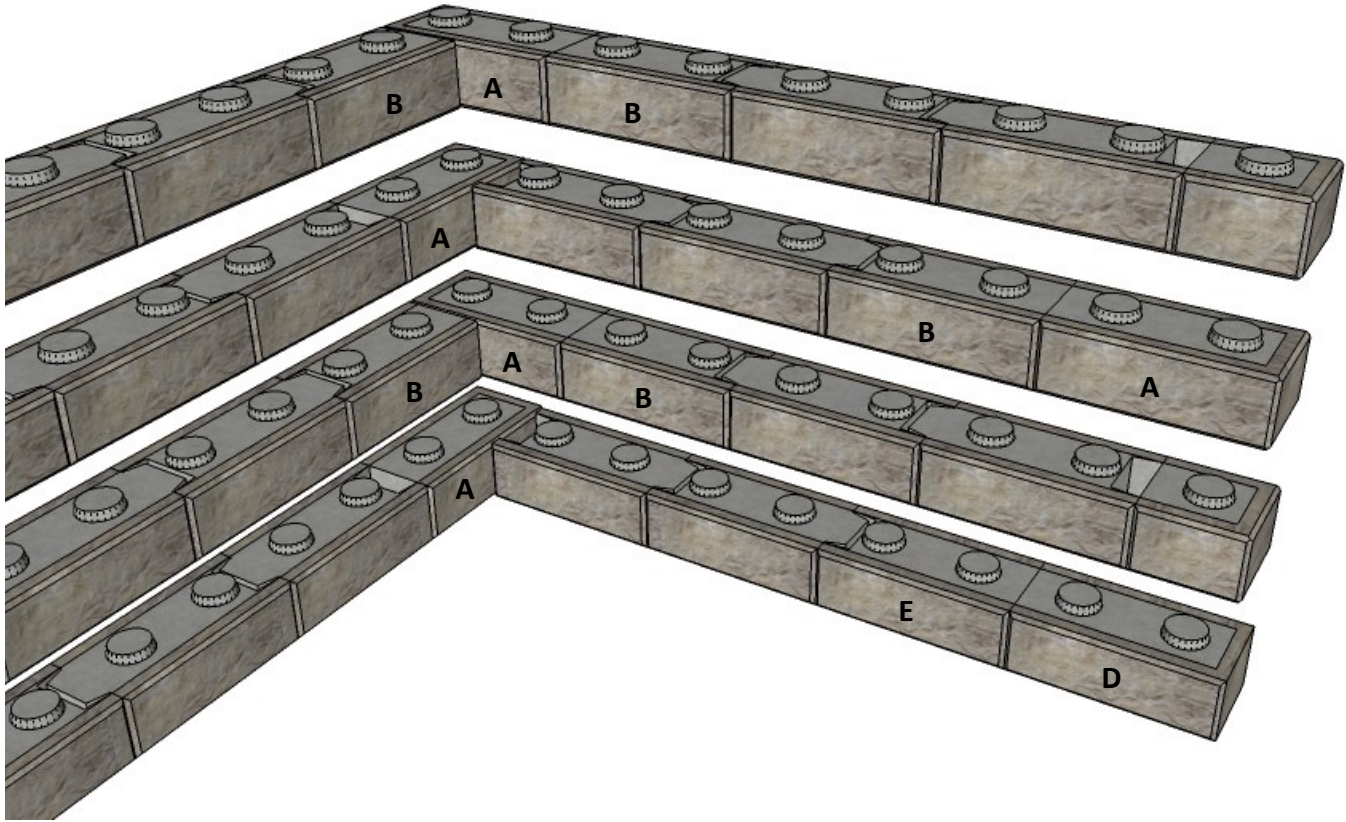

A—Fence Middle End

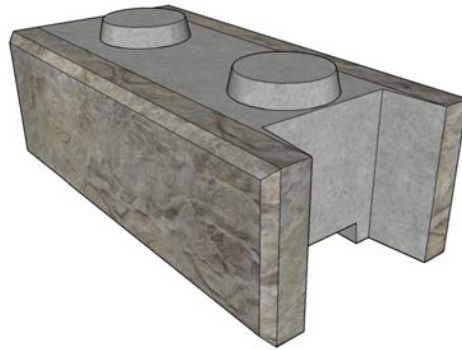

B—Fence Middle Flat End

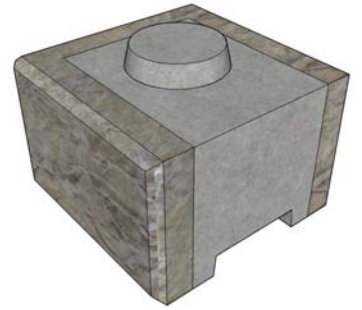

C—Half Fence Middle End



D—Fence Base End

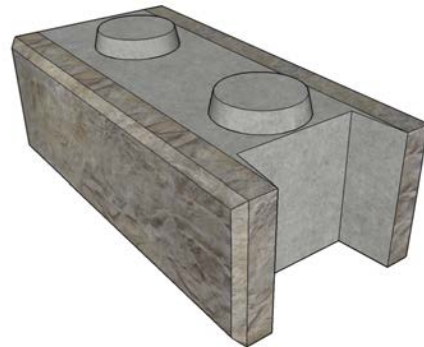

E—Fence Base Flat End

Course Transition

When a ReCon Fence block is placed on top of a ReCon Retaining Wall block, the initial set back in the first course between Retaining Wall Block to Fence Block is 1-1/2-inches. Thereafter, any additional courses of Fence block will go up vertically.

If the wall is level along the top, meaning there is no change in elevation at the top of the wall for the entire length, it is recommended that the Fence block be placed on the Retaining Wall block and the 1-1/2-inch setback be allowed to remain in the wall. It is not significantly noticeable, and from a design perspective it has very little effect.

Often, however, the top of a ReCon wall will change in elevation. In this case, there will be locations along the wall where the same course of block transitions from Retaining Wall to Fence block. When the first Fence block is set on the top of a Retaining Wall block, the setback will be 1-1/2-inches, not 1-inch. This can be noticeable in the wall, and thus the contractor may want to consider transitioning the setback from 1-inch to 1-1/2-inches over a distance of three blocks or 12-feet. This can be done by cutting a small portion off the back of the tongue on the Retaining Wall block. The objective would be to remove 3/8-inch off the first tongue, then 1/4-inch, and finally 1/8-inch. Doing so will allow the wall setback to gradually go from 1-inch to 1-1/2-inches.

The tools needed to make this transition include a chop saw with diamond blade, a string line, a permanent marker, a hammer and a chisel. The drawing illustrates the cuts that can be made to soften the transition. Use the string line and marker to layout the cuts.

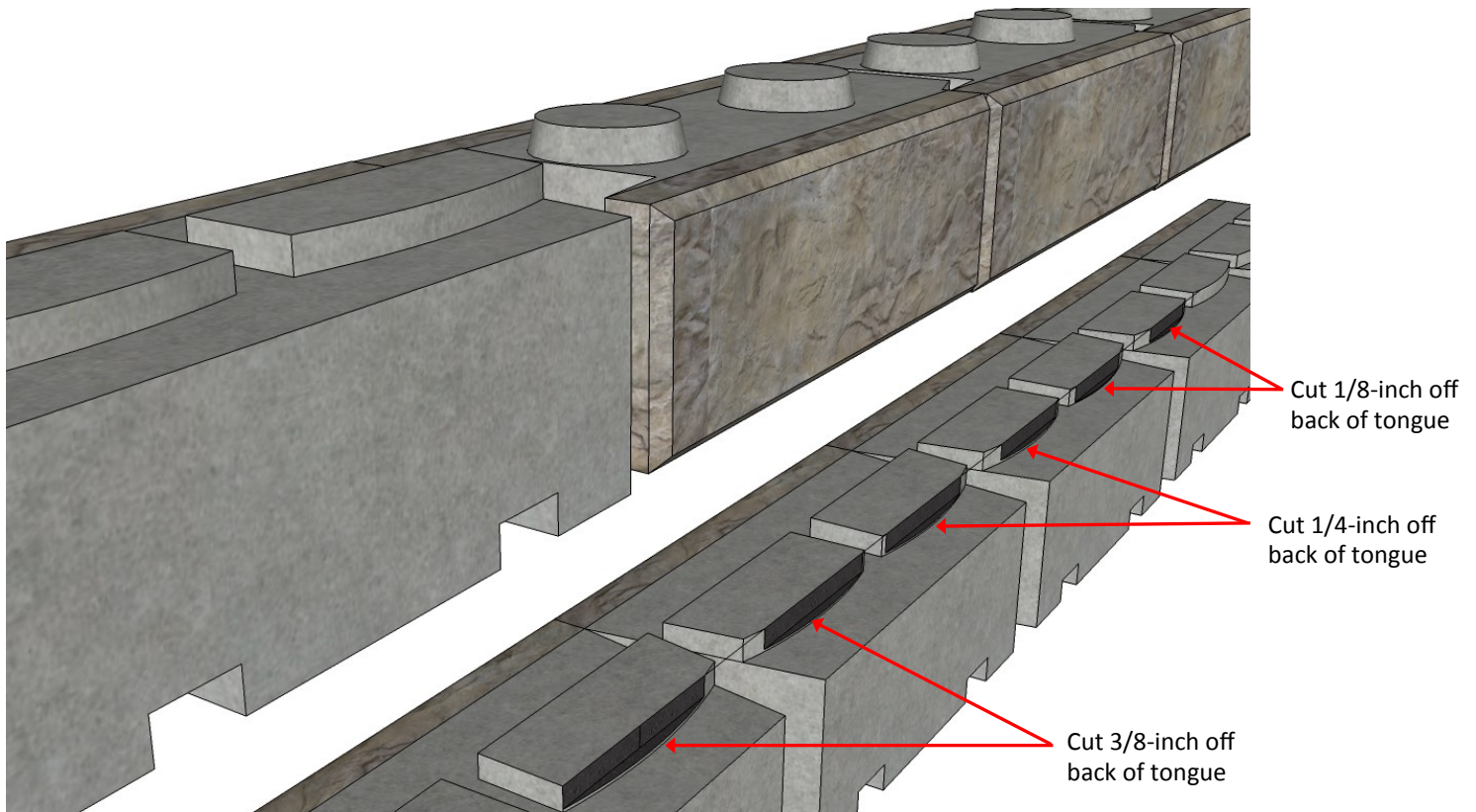

Column Block Installation Options

It is important, when installing free-standing columns that are independent of a retaining wall, that the foundation soils are properly prepared and compacted to achieve the required bearing capacity. Additionally, in areas that are susceptible to freeze thaw cycles it may be required to excavate to a depth beyond the frost line and backfill with concrete and/or a non-frost susceptible material.

Column Block with Fence Rails

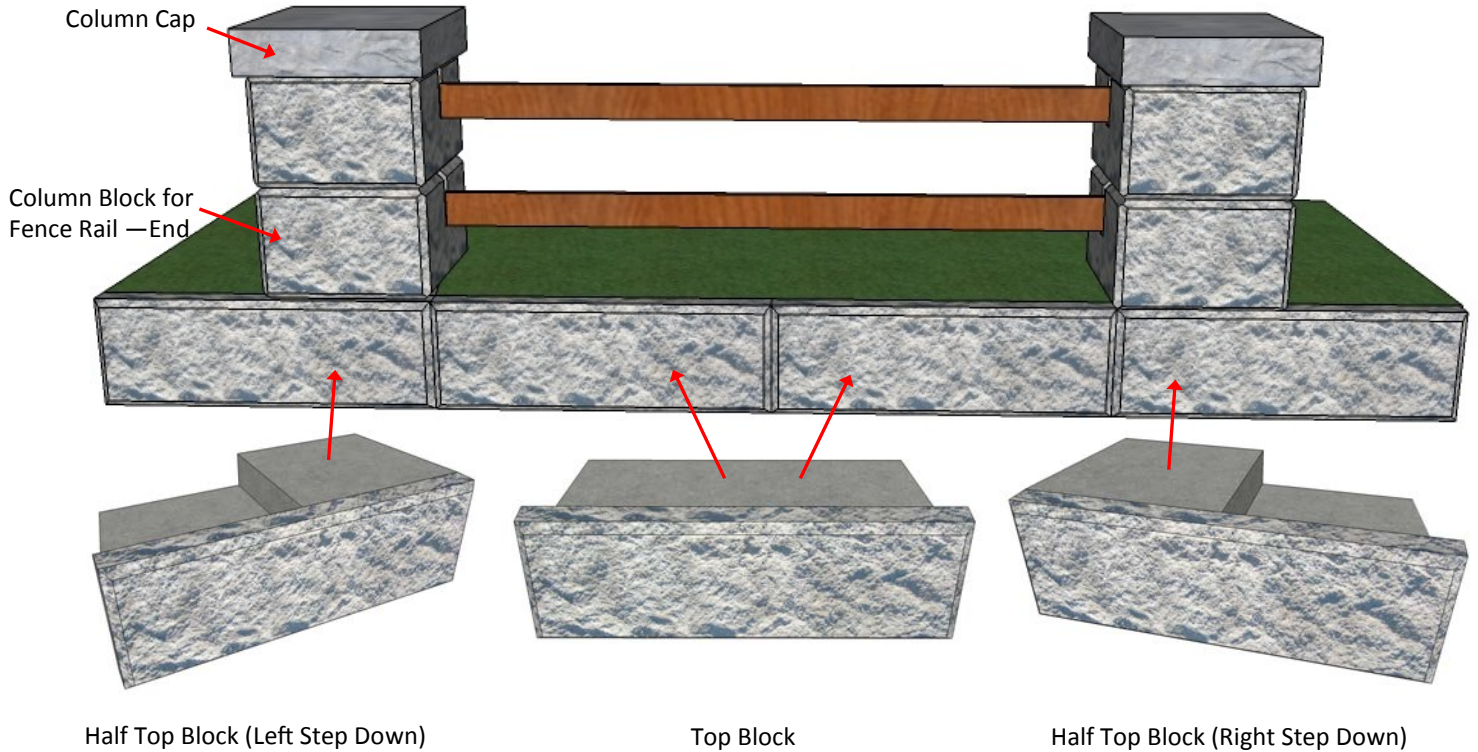

Size of Fence Rail Opening

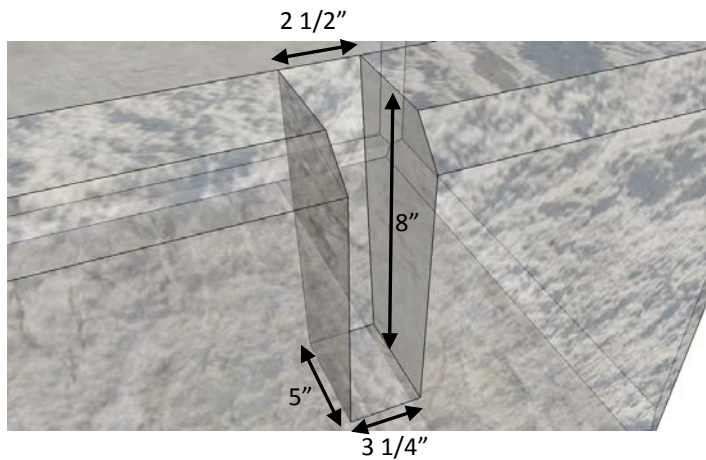

Rail: Wood, Concrete or Plastic
 2.5-inch max width
 4 to 8-inch height
 8-foot 6-inch or 6-foot 6-inch typical length
 (Results in opening between
 Columns being 8-feet or 6-feet)

Column Block with Gate

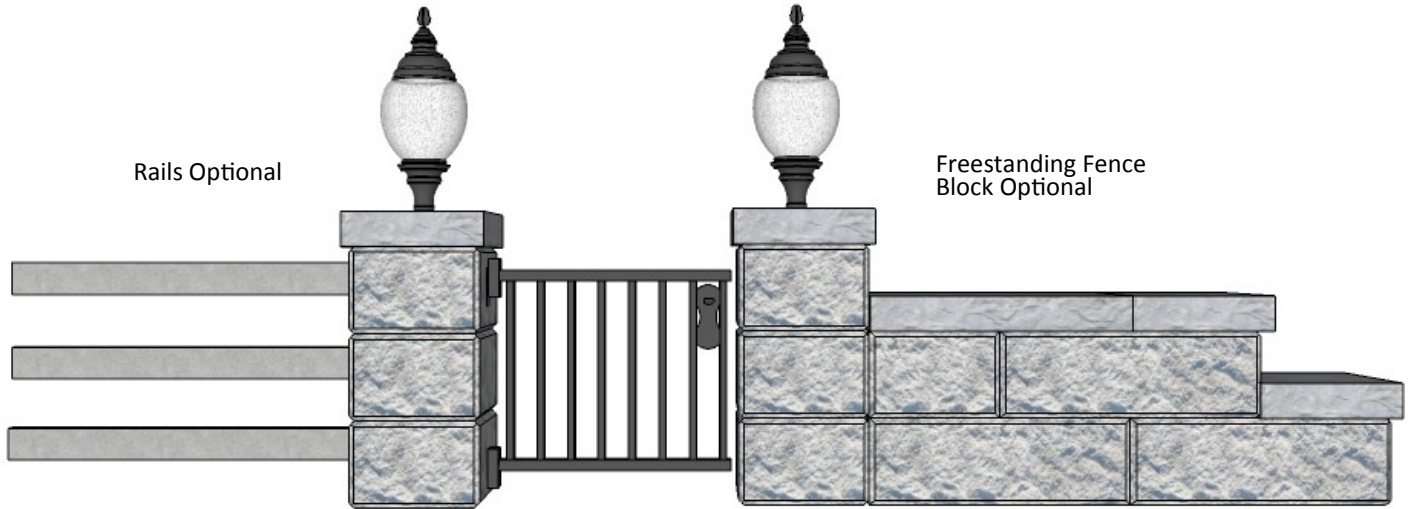

Column Block with Fence

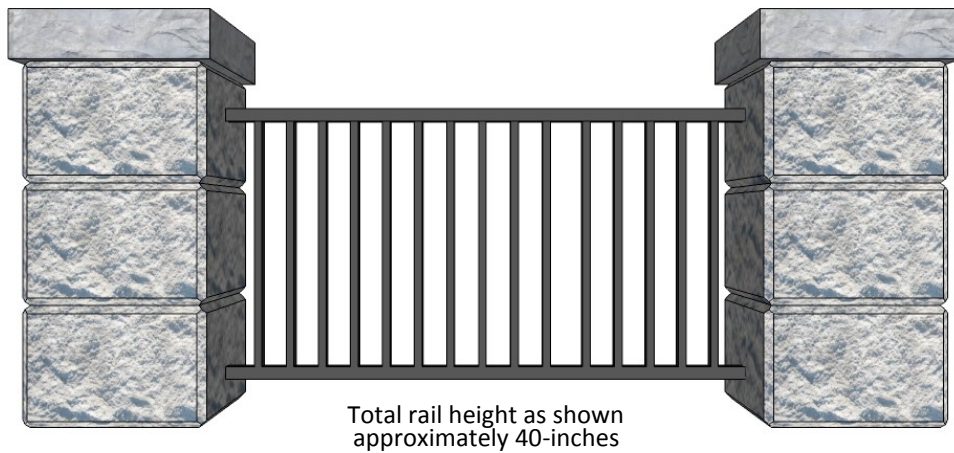

Note: This guide specification should not be included entirely “as-is”. Specification writers must edit areas in red which may or may not be relevant to a specific project or where mutually exclusive choices are referenced.

SECTION 32 32 16 PRECAST MODULAR BLOCK RETAINING WALL

PART 1 GENERAL

1.1 SUMMARY

- A. Section Includes: Furnishing materials and labor required for the design and construction of a ReCon pre-cast modular block retaining wall.
- B. Related Sections:
 - 1. Section 312000 Earth Moving
 - 2. Section 099313.13 Exterior Staining
 - 3. Section 099723 Concrete and Masonry Coatings
 - 4. Section 099623 Graffiti-Resistance Coatings

1.2 REFERENCES

- A. Precast Modular Block Units:
 - 1. ASTM C-33 Specification for Concrete Aggregates
 - 2. ASTM C-39 Test Method for Compressive Strength of Cylindrical Concrete Specimens
 - 3. ASTM C-94 Specification for Ready-Mixed Concrete
 - 4. ASTM C-138 Test Method for Density (Unit Weight), Yield, and Air Content (Gravimetric) of Concrete
 - 5. ASTM C-143 Test Method for Slump of Hydraulic-Cement Concrete
 - 6. ASTM C-172 Standard Practice of Sampling Freshly Mixed Concrete
 - 6. ASTM C-260 Specification for Air-Entraining Admixtures for Concrete
 - 7. ASTM C-494 Specification for Chemical Admixtures for Concrete
 - 8. ASTM C1611 Test Method for Slump Flow of Self-Consolidating Concrete
 - 9. ASTM C-1776 Standard Specification for Wet-Cast Precast Modular Block Retaining Wall Units
- B. Drain Pipe:
 - 1. ASTM D-3034 Standard Specification for Type PSM (Vinyl Chloride) (PVC) Sewer Pipe and Fittings
 - 2. ASTM F-2648 Standard Specification for 2 to 60 inch [50 to 1500 mm] Annular Corrugated Profile Wall Polyethylene (PE) Pipe and Fittings for Land Drainage Applications
- C. Geosynthetics:
 - 1. ASTM D-4595 Tensile Properties of Geotextiles - Wide Width Strip
 - 2. ASTM D-4873 Standard Guide for Identification, Storage and Handling of Geosynthetics
 - 3. ASTM D-5262 Unconfined Tension Creep Behavior of Geosynthetics
 - 4. ASTM D-5321 Standard Test Method for Determining the Coefficient of Soil and Geosynthetic or Geosynthetic and Geosynthetic Friction by the Direct Shear Method
 - 5. ASTM D-5818 Standard Practice for Obtaining Samples of Geosynthetics from a Test Section for Assessment of Installation Damage
 - 6. ASTM D-5970 Standard Test Method for Deterioration of Geotextiles from Outdoor Exposure
 - 7. ASTM D-6637 Standard Test Method for Determining Tensile Properties of Geogrids by the Single- or Multi-Rib Tensile Method
 - 8. ASTM D-6638 Standard Test Method for Determining Connection Strength Between Geosynthetic Reinforcement and Segmental Concrete Units
 - 9. ASTM D-6706 Standard Test Method for Measuring Geosynthetic Pullout Resistance in Soil
- D. Engineering Design:
 - 1. NCMA Design Manual for Segmental Retaining Walls, Current Edition
 - 2. AASHTO LRFD Bridge Design Specifications, Current Edition
 - 3. International Building Code (IBC), Current Edition
 - 4. Minimum Design Loads for Buildings and Structures, ASCE 7, Current Edition
- E. Soils:
 - 1. ASTM D-422 Standard Test Method for Particle-Size Analysis of Soils

2. ASTM D-448 Standard Classification for Sizes of Aggregates for Road and Bridge Construction
 3. ASTM D-698 Standard Test Methods for Laboratory Compaction Characteristics of Soil Using Standard Effort (12,400 ft-lbf/f³) (600 kN-m/m³)
 4. ASTM D-1241 Standard Specification for Materials for Soil-Aggregate Subbase, Base and Surface Courses
 5. ASTM D-1556 Standard Test Method for Density and Unit Weight of Soil in Place by the Sand Cone Method
 6. ASTM D-1557 Standard Test Methods for Laboratory Compaction Characteristics of Soil Using Modified Effort (56,000 ft-lbf/f³) (2700 kN-m/m³)
 7. ASTM D-2487 Standard Classification of Soils for Engineering Purposes (Unified Soil Classification System)
 8. ASTM D-3080 Standard Test Method for Direct Shear Test of Soils Under Consolidated
 9. Drained Conditions
 10. ASTM D-4318 Standard Test Methods for Liquid Limit, Plastic Limit, and Plasticity Index of Soils
 11. ASTM D-4767 Test Method for Consolidated-Undrained Triaxial Compression Test for Cohesive Soils
 12. ASTM D-6938 Standard Test Methods for In-Place Density and Water Content of Soil and Soil-Aggregate by Nuclear Methods (Shallow Depth)
 13. ASTM D-G51 Standard Test Method for Measuring pH of Soil for Use in Corrosion Testing
- F. ReCon Construction Detail Drawings: www.reconwalls.com

1.3 DEFINITIONS

- A. ReCon Retaining Wall Unit: Concrete, modular facing block provided by an authorized manufacturer under license to ReCon Wall Systems, Inc.
- B. Geogrid: A geosynthetic material manufactured of high tensile materials specifically for the purpose of reinforcing and creating a structural soil mass.
- C. Drainage Aggregate: Clean, crushed rock located within and immediately behind ReCon units to facilitate drainage and avoid compaction in close proximity to ReCon wall units.
- D. Reinforced Soil: Soil zone extending from the Drainage aggregate zone to the back of the embedded geogrid.
- E. Foundation Soil: Soil zone immediately beneath the retaining wall facing units, the wall leveling pad and the reinforced soil zone.
- F. Retained Soil: Soil immediately behind retaining wall facing and drainage aggregate for modular gravity structures or behind the reinforced soil for wall that utilize geogrid.
- G. Construction Drawings: Approved final plan for construction prepared and stamped by the wall design engineer licensed to practice in the state where the retaining wall is located.

1.4 Submittals

- A. Contractor shall submit Manufacturer's product data and installation instructions for approval.
- B. Contractor shall submit Manufacturer's test reports certifying that the ReCon units manufactured at their production facility meet the requirements of this specification and the requirements of the Construction Drawings.
- C. Unless provided within these project documents and/or the project drawings, contractor shall submit two sets of the Construction Drawings for all ReCon retaining walls on the project.
 1. The design shall be prepared by a Professional Engineer licensed to practice in the state where the retaining wall is located.
 2. The design shall be per NCMA Design Guidelines for Segmental Retaining Walls, or the AASHTO Standard Specifications for Highway Bridges, whichever is applicable as determined by the retaining wall design engineer.
 3. Construction Drawings shall include:
 - a. The retaining wall layout and retaining wall heights.
 - b. Proper placement, lengths and types of geogrid reinforcement where necessary.
 - c. Typical wall sections.
 - d. Types, locations and properties of all drainage materials, appurtenances and special installation requirements not covered in this specification.
 - e. Retaining wall elevation views.
 - f. Any soils information or testing conducted in addition to that included within the project drawings and specifications.

- g. Design assumptions.
- D. If geogrid reinforcement is required in the final engineered construction drawings, submit manufacturer's product literature, product testing reports and a twelve inch or larger sample of each type to be used in wall construction.
- E. Submit gradation reports for aggregates used for the wall leveling pad, unit / drainage fill and for select reinforced fill if required in the final engineered wall design.
- F. All submittals must be provided and reviewed prior to the start of retaining wall construction.

1.5 DELIVERY, STORAGE, AND HANDLING

- A. Contractor shall inspect all products at delivery to determine that the proper materials have been delivered and are usable. Damaged material shall not be incorporated into the work.
- B. ReCon retaining wall units shall be stored in a location and manner that protects against excessive weathering and damage.
- C. Contractor shall prevent ReCon units from excessive soiling and coming in contact with substances which may stain or adhere to the finished visual surfaces of the unit.
- D. Faces of the ReCon Block shall be free of excessive chipping, cracking and stains.

1.6 QUALITY ASSURANCE

- A. Installer Qualifications: Contractor shall have successfully installed at least three projects similar to that of this project within the last two years. Contractor shall maintain at least one mechanic on site at all times that worked on one or more of these previous installations.
- B. Owner shall employ the services of an independent geotechnical or materials engineering firm to provide soil testing and quality assurance inspection for wall construction and soils work. Contractor shall provide any quality control testing or inspection not provided by the Owner.
- C. Retaining Wall Design Engineer Qualifications: The Retaining Wall Design Engineer shall be licensed to practice in the state in which the project is located. Additionally, the Retaining Wall Design Engineer shall be independently capable of performing all retaining wall analysis calculations (internal and external stability, seismic analysis, water analysis, and global stability) and have designed at least three wall projects similar to that of this project.

PART 2 PRODUCTS

2.1 MANUFACTURERS

- A. Only licensed and authorized manufacturers of:
 1. ReCon Wall Systems, Inc.
7600 West 27th St., #229
St Louis Park, MN 55426
(952) 922-0027 Phone
(952) 922-0028 Fax
www.reconwalls.com

2.2 MATERIALS

- A. ReCon retaining wall units.
 1. The block unit shall consist of concrete with the average 28-day compressive strength of no less than 4000 psi.
 2. Concrete shall have air entrainment by volume (as measured in the plastic state in accordance with ASTM C172) of:
 - a. 5.5 – 8.5 percent, or
 - b. In conformity with ASTM C94, latest revision.
 3. Exterior dimensions of the face shall be 48-inches by 16-inches for full and corner unit, and 24-inches by 16-inches for half unit.
 4. Depth of unit should be as per Construction Drawings and is available in depths from 24-inches up to 84-inches (dimensions in inches: 24, 39, 45, 60, 66, 72, 78, 84).
 5. ReCon Units used shall maintain tolerances of:
 - a. Height: +/- 3/16-inch
 - b. Width: +/- 1/2-inch unless field cut for fitting purposes.
 - c. Depth: No less than the unit design depth (i.e. 24-inch, 39-inch, etc.) with the textured face portion of the block being considered as 4-inches

6. Special shape units should be obtained and used where indicated on the final engineered construction drawings. Reference ReCon Drawing #101 for overview of standard unit types.
7. ReCon Unit Face Texture [Specify choice (or choices) as required. Check local availability]:
 - a. Shall be "LeSueur County Limestone"
 - <or>
 - b. Shall be "North Shore Granite"
 - <or>
 - c. Shall be "Old World"
 - <or>
 - d. Shall be "Rustic"
 - <or>
 - e. Shall be "Weathered Edge"
- B. Geogrid Reinforcement: Geosynthetic reinforcement shall be high tensile geogrid or geotextile manufactured specifically for soil reinforcement applications.
 1. Construction Drawings shall indicate the type, strength, location and lengths of reinforcement used.
 2. The geosynthetic manufacturer shall provide all relevant testing to the wall design engineer for incorporation in the wall design and shall be included in the submittal for the Construction Drawings.
 3. No substitutions of geosynthetic shall be allowed that was not evaluated in the Construction Drawings.
- C. Base Leveling Pad: The wall base leveling pad material shall consist of a compacted crushed stone base or non-reinforced concrete as indicated in the Construction Drawings.
- D. Drainage Aggregate: Drainage aggregate shall consist of clean 3/4" crushed stone or gravel meeting the requirements of the Construction Drawings.
- E. Reinforced Soil: All reinforced soil, borrow or imported, shall meet all requirements of the Construction Drawings. Reinforced soils, by gradation, shall have no more than 35 percent passing the number 200 sieve for walls less than 20-feet in height and no more than 15 percent passing the number 200 sieve for walls greater than 20-feet in height.
- F. Drainage Pipe: If required in Construction Drawings, drainage pipe shall be perforated, slotted or corrugated pipe manufactured in accordance with ASTM D-3034 or ASTM F-2648. Drainage pipe may also be covered with a geotextile filter fabric.
- G. Unit Adhesive: Adhesive shall be a premium, construction grade suitable for concrete and exterior applications.

2.3 FINISHES

- A. ReCon retaining wall color [Specify choice (or color) as required]
 1. Finished wall shall be left in natural (as-cast) color.
 - <or>
 2. Finished retaining wall shall be stained in accordance with Section 099313.13 "Exterior Staining".
 - a. Acceptable product stains:
 1. Sherwin Williams H & C SHIELD PLUS CONCRETE STAIN
 2. TK Products TRI-SHEEN PIGMENTED STAIN TK-5272
 - b. Color shall match [Define reference or sample to match]
 - <or>
 - c. Color shall be [Designate existing color]
 3. Sealing [Optional, list here and specify in Section 099723 Concrete and Masonry Coatings or 099623 Graffiti Resistant Coatings]
 - a. Acceptable sealers and anti-graffiti coatings
 1. TK Products TK-290 Tri-SILOXANE OTC (sealer)
 2. TK Products 1496 TK Prermaclean OTC (anti-graffiti)

PART 3 EXECUTION

3.1 EXAMINATION

- A. Verify locations of utilities and existing structures prior to excavation.
- B. Examine the Project site and evaluate conditions where the ReCon retaining wall will be constructed. Notify the proper supervising authority in writing of any conditions that may interfere with the proper construction of the ReCon wall or delay completion.
- C. Promptly notify the wall design engineer of site conditions which may affect wall performance, soil conditions observed other than those assumed, or other conditions that may require a reevaluation of the wall design.

3.2 EXCAVATION

- A. Contractor shall excavate to the lines and grades shown on the construction drawings. The contractor shall be careful not to disturb the base beyond the lines indicated.
- B. Foundation soils shall be excavated as required for footing base / leveling pad dimensions shown on the construction drawings, or as directed by the wall engineer.
- C. Over-excavated areas shall be filled with suitable base or backfill material and compacted to 95 percent standard proctor.

3.3 FOUNDATION SOILS PREPARATION

- A. Foundation soils shall be evaluated by a Geotechnical Engineer or Owners Representative to ensure that the bearing soils meet or exceed the design conditions or assumptions.
- B. Compact foundation soil zone to 95 percent standard proctor prior to installing base / leveling pad.

3.4 BASE / LEVELING PAD

- A. Base shall be located as indicated on the Construction Drawings and shall have a minimum thickness of 6-inches. Base materials are to be as specified by the wall engineer (generally crushed stone, 3/4-inch minus, or similar).
- B. Width of the base pad must extend a minimum of 6-inches in front and 6-inches in back of the ReCon Base Block footprint.
- C. Base material shall be compacted so as to provide a smooth, hard surface on which to place the first course of units.
- D. Compact base material to 95 percent of standard proctor.
- E. Base shall be prepared to ensure full contact of the wall unit with base material. Spacing or gaps between units shall no exceed 1/2-inch.
- F. Contractor may elect to substitute a portion of the specified granular base materials with a lean, unreinforced concrete topping.
- G. When a reinforced footing is required by the Construction Drawings, it shall be located below the frost line.

3.5 UNIT INSTALLATION

- A. First course of units shall be Base Block units and shall be placed in full contact with the base material.
- B. Check units for level from side-to-side, front to back, and check to maintain unit batter front-to-back.
- C. Place unit faces in contact side to side and avoid any gaps greater than 1/2-inch.
- D. Fill and compact fill to grade in front of embedded units prior to compaction behind the wall units.
- E. Fill voids between ReCon units with 3/4-inch clean crushed rock to a distance of one foot behind the unit depth unless otherwise instructed in the Construction Drawings.
- F. Sweep and clean the top of each course before setting additional courses.
- G. Lay each successive course making sure that the bottom recess is in full contact with the unit locators of the course below. Pull unit forward as far as possible. Backfill and compact soil behind the units.
- H. Check and maintain level and wall batter by use of shims when necessary.
- I. Follow ReCon recommended procedures to maintain acceptable running bond when constructing curved walls and / or corners. Build in accordance with Construction Drawings or ReCon Construction Detail Drawings.

- J. Handle units with proper lifting devices that have been certified for the loads associated with the weights of the units. Avoid applying forces to the lifting loops in excess of the normal force associated with the weight of the unit (i.e., avoid dynamic loads from bouncing or swinging of a unit). If the unit is to be transported over a significant distance in the field, it is recommended that a CABLE be used in lieu of a chain.

3.6 GEOGRID INSTALLATION

- A. Install geosynthetic reinforcement in accordance with manufacturer's recommendations and the Construction Drawings.
- B. Locate geosynthetic reinforcement at elevations and to the lengths shown on the Construction Drawings.
- C. Prior to installation of geosynthetic reinforcement, level and compact backfill material to the level of the reinforcement layer.
- D. Reinforcement design strength direction must be oriented perpendicular to wall face.
- E. Position reinforcement on ReCon units over the tongue and groove and to within 2-inches of the front exposed face. The next course of units shall be placed such that the geogrid is deformed over the tongue and groove. The next course of units must be slid forward such that the back edge of the groove on this unit is up against the back edge of the tongue on the lower unit with the geogrid pinched between the tongue and groove. Hold in place by installing the next course of units.
- F. Remove all wrinkles or folds in reinforcement by pulling taut prior to backfill placement. Secure using soil staples, stakes or hand tension until reinforcement is covered with sufficient fill to maintain tensioned position.
- G. Reinforcement shall be continuous throughout the embedment length. Splicing along reinforcement strength direction is not allowed.
- H. Position reinforcement sections side-by-side to provide 100 percent coverage along wall face.
- I. Where curved wall sections cause overlap areas in reinforcement, maintain at least 3-inches of soil between layers where overlap occurs.

3.7 REINFORCED BACKFILL PLACEMENT

- A. Wall fill material shall be placed in lifts no greater than 8-inches in depth and shall be less if necessary to achieve necessary compaction.
- B. Compact backfill material to 95 percent of standard proctor.
- C. Only hand-operated compaction equipment shall be used within 3-feet of the back of the ReCon unit. Heavy-duty compaction equipment should be kept a minimum of 5-feet from the back of the ReCon unit to avoid wall rotation.
- D. Wherever possible, backfill should be placed beginning at the face of the wall. Backfill shall be placed, spread, and compacted in a manner that minimizes the development of wrinkles, folds or movement of geogrid.
- E. Tracked construction equipment shall not be operated directly on the geogrid. A minimum backfill thickness of 6-inches is required prior to operation of tracked vehicles over the geogrid. Turning of tracked vehicles should be kept to a minimum to prevent tracks from displacing the fill and damaging the geogrid.
- F. Rubber tired equipment may pass over the geogrid reinforcement at slow speeds, (less than 10 MPH). Avoid sudden braking and sharp turning.
- G. At the conclusion of each day's work, slope backfill at both the crest and bottom of wall away from wall face to prevent surface drainage from scouring or ponding.
- H. During wall construction, the General Contractor shall be responsible for coordination of other project site operations so as to avoid adjacent construction site drainage from affecting wall construction area.
- I. Upon completion of wall construction work, the General Contractor shall:
 - 1. Ensure finished grading directs normal drainage away from the finished wall.
 - 2. Ensure other trades do not operate heavy equipment or excavate near the wall and reinforced soil zone.

3.8 OTHER CONSTRUCTION DETAILS

- A. ReCon provides a number of Construction Detail Drawings (see Section 1.2F) which can be found on ReCon's website (www.reconwalls.com) and should be referred to for guidance on wall specific applications.

3.9 SITE TOLERANCES

- A. Straight walls
 - 1. Vertical Alignment: +/- 1.5-inches over any 12-foot distance and no more than +/- 3-inches over the entire length of wall.
- B. Horizontal Alignment Control:
 - 1. Corners and radius location: +/- 1-foot to theoretical location indicated on the Grading Plan.
 - 2. Radii: +/- 2-feet from theoretical lines indicated on the Grading Plan.
- C. Wall Batter at Completion of Work: +/- 2-degrees from the design batter and no batter less than 2-degrees.

3.10 FIELD QUALITY CONTROL

- A. Contractor shall be responsible for proper installation and quality control of all ReCon wall components and appurtenant materials.
- B. Owner shall, at their expense, retain a qualified professional to monitor and perform quality assurance checks of the installer's work.
- C. Quality Assurance should include foundation soil inspection, frequent backfill compaction testing, verification of geotechnical design parameters and compliance with Construction Drawings and Project Specifications.

3.11 CLEANING

- A. After completion of wall installation, remove construction debris and restore any adjacent finished areas affected by wall construction to their pre-construction state.
- B. Wash wall face to remove soiling and stains. Do not use acid or detergents that may "burn" or discolor face.

3.12 STAINING / SEALING (Optional)

- A. Provide samples of stained / sealed faces for approval prior to commencing application to ReCon retaining wall units. Samples shall be large enough to demonstrate scope of color variation.
- B. Install stain / sealer in accordance with manufacturers recommended procedures.

Warranty

Each Block will have 28 day compressive strength of at least 4000 PSI for 15 years after proper installation. If a Block does not meet this warranty standard, please notify the manufacturer in writing. If after it has been determined that the Block has not met the specifications, the manufacturer will have shipped to you, replacement Blocks which shall be the manufacturer's sole remedy for breach of this warranty. However, neither the manufacturer nor ReCon Wall Systems, Inc. shall have any obligation to install such replacement Blocks.

This warranty shall not apply to any Block which is damaged, defective or fails to meet the warranty standard due to improper installation of the Block, chemical contact, structural design of the wall, or excessive and unforeseen site conditions beyond the manufacturer's or ReCon Wall Systems, Inc.'s control.

The above warranty is the exclusive limited product warranty. ALL OTHER WARRANTIES, EXPRESS OR IMPLIED, INCLUDING WARRANTIES OF MERCHANTABILITY OR FITNESS FOR A PARTICULAR PURPOSE, ARE DISCLAIMED.



ReCon Wall Systems, Inc.
7600 West 27th Street
Suite 229
St. Louis Park, MN 55426
(952)922-0027
(952)922-0028 (Fax Line)
sales@reconwalls.com
www.reconwalls.com

Distributed By:



5th Revision—April 2017

©2017 ReCon Wall Systems, Inc. Proprietary to ReCon, all rights reserved.